

JULY, 1927

25 CENTS

RADIO

(REG. U. S. PATENT OFF.)

PREMIER DISPLAY
OF NEXT SEASONS
RADIO MODELS

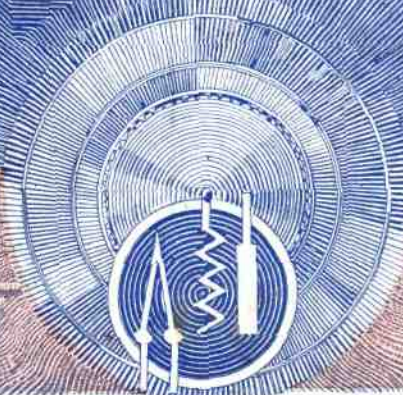
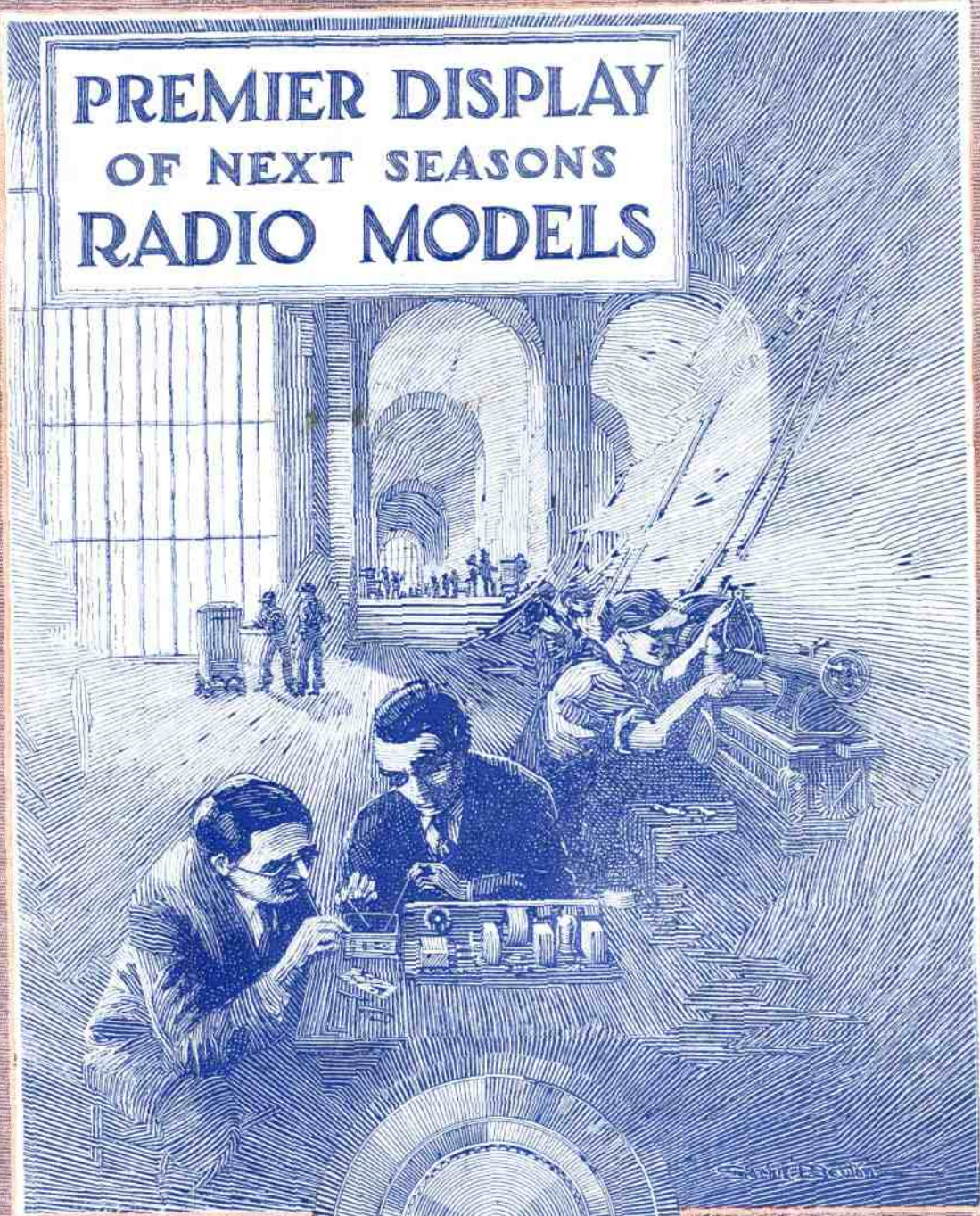

JULY 1927

RADIO

25 CENTS



Cunningham RADIO TUBES



CX
340

Price
\$2.25

*For Resistance and Impedance—
coupled Audio Frequency Amplification*

THE secret of success in resistance or impedance-coupled audio frequency amplification lies in the use of properly designed high-mu tubes.

The New Cunningham CX-340 high-mu tube brings to resistance and impedance-coupled audio frequency amplification efficiency heretofore unattainable with previously existing types of tubes.

A new tube, for a new need, the CX-340 completes, for present needs, the Cunningham line of 16 Special Purpose Tubes. Each type of tube is designed to perform a definite and particular task in radio receivers.

Whenever a new type of tube is needed, Cunningham will produce it, but not before it is practical and has passed the laboratory stage of its development.

Consult your radio dealer. He will tell you the right combination of Cunningham Radio Tubes for your receiver.

CX-340 and fifteen other types in the orange and blue carton.

Operating Characteristics

Amplification factor (mu)	30
Filament Operating Voltage	5 volts
Filament Current Consumption	.25 amp.
Recommended Plate Voltage	135 to 180 volts
Plate Resistance (at 135 to 180 volts, under operating conditions; not at zero grid bias)	150,000 ohms
Recommended plate resistor	.25 meg.
Recommended grid resistor (grid leak)	1 to 2 meg.
Recommended coupling (blocking) condenser	.005 to .05 mfd.

Plate and Grid Voltage values		
"B" Voltage volts	Grid Bias volts neg.	Plate Resistor megohms
135	1 to 1.5	.25
180	3	.25
above 180	3 to 4.5	.5 to 1

E. T. CUNNINGHAM, Inc.

NEW YORK

CHICAGO

SAN FRANCISCO



It's Here!

for the First Time
**Dependable FULL POWER
 Electric Light-socket
 Operation at LOW COST**



SOME OUTSTANDING FEATURES

- FULL POWER *under all loads.*
- ABSOLUTELY NOISELESS.
- NO DISTORTION. *No loss in volume.*
- SET SWITCH *controls everything.*
- WORKS AUTOMATICALLY.
- OPERATES *any standard receiver without re-wiring.*
- NO TUBES *to replace.*
- COSTS LESS *to operate than average light bulb.*
- OPERATES *all sets using from 3 to 10 (6 volt) tubes, including power tube.*
- AMAZINGLY LOW PRICE.
- MADE BY *a manufacturer of recognized standing—over 2,000,000 Tower Radio Products now in use.*

Tower

"A" and "B"

SOCKET POWER UNITS

The phenomenal advance of the radio art is nowhere better exemplified than in the new Tower Socket Power Units. Now—for the first time—you can obtain from your house lighting current that steady, uniform flow of radio energy—long sought but never before accomplished in a wholly satisfactory manner.

No more recharging storage batteries—no more "B" batteries to replace—no more apologies necessary for poor tone quality or volume.

Here — at last — is radio socket power that is FOOL PROOF—as easy to operate as an electric fan, supplying adequate power for any multi-tube receiver without change in wiring on 100-125 Volt, 60 Cycle, A. C.

Again Tower achieves the unusual—Radio Socket Power is now available for all. Descriptive matter on request.

TOWER MFG. CORP. Boston, Mass.

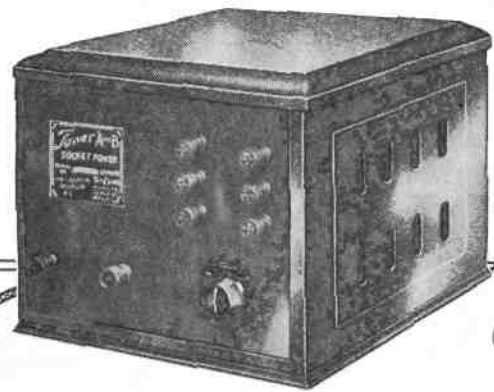

"A" and "B" Combination \$59.50

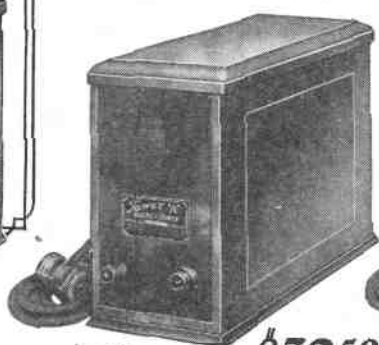

"A" Power \$32.50



"B" Power \$32.50

Dependable, economical "A" Supply. Delivers FULL Power under all loads. Absolutely no hum!

Most powerful "B" Supply Unit on the market. Furnishes voltages indicated on terminals. No guesswork.

RADIO

With Which Is Incorporated "Radio Journal"

Established 1917

Published Monthly by the Pacific Radio Publishing Co.

ARTHUR H. HALLORAN,
Editor

GERALD M. BEST,
Technical Editor

H. W. DICKOW,
Business Manager

A. I. RIVETT,
Draughtsman

Branch Offices:

New York City, 20 East 42nd St.
Chicago, 307 N. Michigan Ave.
Boston, 86 St. Botolph St.
Kansas City, Mo., Davies & Dil-
lon, 707 Land Bank Bldg.

Rates:

Issued Monthly, 25c a copy.
Subscription price, \$2.50 per year
in the U. S., \$3.00 per year else-
where.

Correct Addresses:

Instructions for change of address
should be sent to the publisher
two weeks before the date they
are to go into effect. Each old
and new address must always be
given.

Advertising:

Advertising Forms Close on the
First of the Month Preceding
Date of Issue.

Member Radio Magazine Publishers' Association
Entered as second-class matter at Post Office at San Francisco, Calif.
Copyright 1927 by the Pacific Radio Publishing Co.

Address all communications to

Pacific Radio Publishing Company

Pacific Building, San Francisco, California

VOLUME IX

JULY, 1927

NUMBER 7

CONTENTS

COVER DESIGN: NEXT SEASON'S RADIO. <i>By Sarkis Beulan</i>	PAGE 23
RADIOTORIAL COMMENT <i>By Arthur H. Halloran</i>	24
ALASKA REACHES OUT <i>By Roy A. Anderson</i>	25
"ABC" SOCKET POWER FOR LARGE TUBES. <i>By G. M. Best</i>	29
TROUBLE SHOOTING THE SINGLE CONTROL SET. <i>By Max P. Gilliland</i>	30
RECENT IMPROVEMENTS IN RESISTANCE COUPLING. <i>By Arthur H. Lynch</i>	31
MAHONEY'S HUNCH <i>By Earle Ennis</i>	33
A TRIP THROUGH THE R. M. A. SHOW AT CHICAGO.	35
SOME OF THE NEW FACTORY BUILT RECEIVERS.	37
NEW KITS AND CIRCUITS FOR THE RADIO BUILDER.	37
THE 1928 INFRADYNE.	38
THE LEUTZ UNIVERSAL TRANSOCEANIC.	39
VACUUM TUBE CHARACTERISTICS.	41
SOCKET POWER DEVICES.	42
METERS FOR RADIO.	43
VARIOUS NEW LOUDSPEAKERS.	45
NEW PARTS FOR THE RADIO BUILDER.	51
BROADCAST STATION ALLOCATIONS.	53
QUERIES AND REPLIES.	54
THE COMMERCIAL BRASS POUNDER. <i>By P. S. Lucas</i>	54
CANADIAN SHIP INSTALLATION. <i>By C. W. Rados</i>	55
MAKING FRIENDS WITH THE ARC. <i>By Rawson B. Dixon</i>	56
WITH THE AMATEUR OPERATORS.	57
A 50-WATT TUNED GRID-PLATE TRANSMITTER. <i>By G. M. Best</i>	

Forecast of Contributions for August Issue

A. L. Young, associate radio engineer in the Navy, in an article on "Short Wave Communication" traces its adoption by the Navy after it had been tried out by the amateurs. He discusses its skip distance effect and describes the use of short waves by both the Army and the Navy.

— : —

J. E. Anderson discusses "Phase Relations in Radio," explaining their meaning and their influence on the stability of audio amplifiers. This article is fully up to the high standard set by Mr. Anderson in the past and clarifies many points in this little-understood subject.

— : —

Samuel G. McMeen resumes his series of articles on "Experimental Shop Methods." In this installment he offers suggestions on the choice and treatment of various kinds of woods for radio panels and cabinets.

— : —

G. M. Best describes the construction of a two-stage five-watt power amplifier using one high mu and one five-watt power tube. This amplifies the output of the detector or first audio stage of a receiver so that it gives ample volume for a small hall. This will be followed up next month with a description of a 50-watt amplifier for use with a number of loudspeakers.

— : —

The experimentally inclined reader will be interested in the "Impedance Equalized Receiver" as described by Francis Churchill. It is designed to give uniform sensitivity and selectivity over the entire broadcast band of wavelengths.

— : —

A. Binneweg, Jr., describes an 80-meter telephone transmitter that will interest the amateur operator. It is adapted for use with the ordinary 7½-watt installation.

— : —

Geo. B. Hart tells how to measure very small r. f. currents with a d. c. milliammeter and vacuum tube.

— : —

Hugo E. Anderson details the construction of a cheap and efficient stand-off insulator for a short-wave transmitter.

— : —

The static and dynamic characteristics of a double grid vacuum tube are discussed by Harry R. Lubcke.

— : —

The amateur operator will also be helped by Don C. Wallace's article on a clickless high power d. c. transmitter.

Jennings B. Dow gives "Two Reasons Why Transmitting Tubes Go West."

— : —

The fiction feature is "Sweetheart's Love Affair," by Jan Dirk. "Sweetheart" is a radio character who was first introduced in May, 1926, RADIO.

*Drum notes not only heard —
but identified*

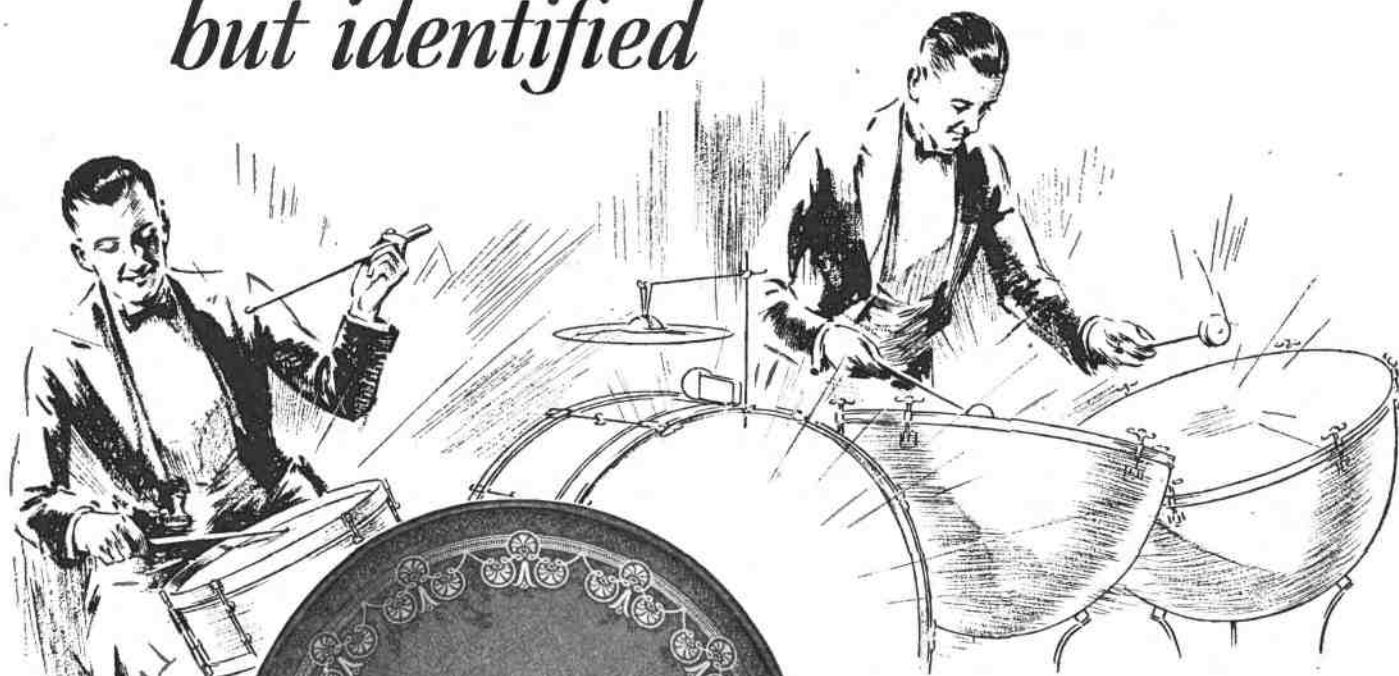

Thousands of radio listeners will now realize for the first time that radio orchestras have drums when they hook up this new, improved Crosley Musicone.

As originally produced the Musicone startled the radio world, eclipsing the old type horn and squeaky speaker.

Today, the new Musicone with its latest refinements and improvements correspondingly leads its host of imitators.

Prepare for a real surprise when you hear this amazing device with its beauty and fidelity of treble reproduction—clarity and breathless reality in middle tones—richness and resonance of bass. Today—infinitely bettered and superlatively developed, the Musicone is the world's finest loud speaker—and, at such extremely low prices, it's the world's greatest radio value.

The Crosley patented actuating unit (and not the cone) is the secret. There's nothing else like it.

Write Dept. 19 for descriptive literature.

*The
improved*

CROSLEY MUSICONE

SUPER-MUSICONE

16 inch Cone

\$14.75

THE CROSLEY RADIO CORPORATION

Powel Crosley, Jr.
Pres.



Cincinnati,
Ohio

Prices slightly higher west of the Rocky Mountains

ULTRA-MUSICONE

12 inch Cone

\$9.75

Tell them that you saw it in RADIO

An Old Friend with a New Name

Ernst Tyrman, president
of his own company,
the Tyrman Electric
Corporation

Radio fans and the trade will be glad to learn that Mr. Ernst Tyrman, designer of the famous nine-in-line receiver, is now head of his own company and is offering a new line of radio equipment of exceptional proven merits. Mr. Tyrman, who has devoted the greater part of his life to the development of laboratory-built receivers, is possibly best known to fans for his popular kit of last year, which outperformed all other receivers. His transformers definitely secured for him the universal approbation of the entire radio field.

First Sought Performance

Last year Mr. Tyrman concentrated on producing equipment that would be more efficient than existing apparatus. How well he succeeded is told by the marvelous reception records achieved with his transformers. Since that time Mr. Tyrman has accomplished greater efficiency for his products and an appearance that makes it possible for the set builder to construct a receiver as presentable as the most costly of manufactured sets.

Introducing Transformers of New Designs

Mr. Tyrman now offers a higher standard of radio frequency and Audio transformers, never before possible to obtain at any price. Three kinds of radio frequency transformers are introduced. One type tuned between 160 and 360 meters, one between 200 and 550 meters, and one a long wave unit. The Tyrman Electric Corporation guarantee their radio frequency transformers to be matched to a fraction of a kilocycle, which is assured through the finest of modern laboratory equipment. The new Audio transformers are unique in design being octagonal in shape, to save considerable space. Three types are manufactured—a straight three to one transformer, a power input and a power output transformer. These units are built for uniform amplification of all frequencies, including the lowest notes obtainable by musical instruments up to their full volume.

ETC—GUARANTEES AND SATISFACTION TO

The Tyrman Vernier Drum

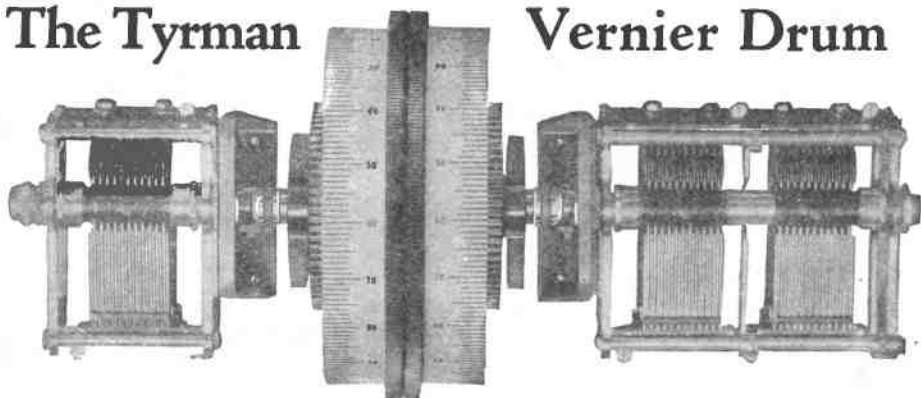

Is the answer to the demand for better appearance plus superior performance. It combines direct and vernier tuning, and represents a perfection of workmanship that assures its instant popularity. Mounting holes for all popular condensers are provided.

Single dial control sets.....Price \$5.00
Two dial control sets..... 10.00

Kurz-Kasch Capacity Connector



An entirely new patented device never before offered to the public. The Kurz-Kasch Capacity Connector eliminates 90% of the wiring and acts as a by-pass condenser between all battery leads. It conforms to the best engineering requirements and is highly praised and recommended by the leading engineers of the country.
Price \$7.50

For Better Looks

Many attempts to beautify the home made set had proven unsatisfactory so after achieving the utmost or final step to transformer efficiency, Mr. Tyrman turned his attention to appearance. This problem he solved by inventing a handsome and accurate vernier drum. This rich appearing instrument consists of two 5½-in. drums made of heavy bakelite mouldings with silver graduations. An exceptionally high grade etched bronze escutcheon plate frames the drums and verniers on

the front panel. It is a completely successful heavy-g geared vernier with a total absence of backlash. The construction contains a flexible bearing for the vernier gear, which is kept in steady mesh with the gears of the large drums by a spiral spring. The movement represents the smoothest action obtainable in this type of apparatus and makes tuning more pleasant than other constructions where mesh is secured by close friction. A very durable shaft connects the vernier and large drums to the condensers, which

EXCELLENCE—ETC

JOBBER, DEALER AND FAN



Tyrman Shielded Socket

A single hole, sub-panel or baseboard mounting socket that allows each tube to function under the influence of magnetic and static fields, an achievement long desired and secured only by Mr. Tyrman's new design. Shielding is of heavy aluminum—the best heat conductor obtainable, which radiates uniformly and keeps the tube temperature constant. Price \$1.25

Tyrman Transformers

AUDIO TYPE

Tyrman Audio Transformers are of unique design as shown in illustration. They are of a heavy type and will amplify uniformly to the lowest audible frequencies. They represent the finest apparatus of their kind. Designed for those whose aim is to perfect tone quality beyond the limits heretofore expected. Types 3-50 and 3-51 are specially for use with UX-112 or UX-171 tubes.

Type 3-30	Ratio 3 to 1.....	Price \$8
Type 3-50	Power input transformer for second audio stage.....	10
Type 3-51	Power output transformer for second audio stage.....	10

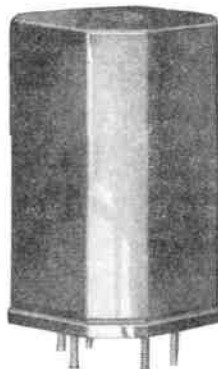

RADIO FREQUENCY TYPES



These new types guarantee a higher standard of excellence and quality than characterized by Mr. Tyrman's units of last year. They are absolutely guaranteed to be matched to a fraction of a kilocycle. Terminals of these units will accommodate the use of the Kurz-Kasch Capacity Connector. All Tyrman Radio Frequency transformers are encased in genuine bakelite mouldings.

R. F. Type 8-70	200 to 550 meters.....	Price \$4
R. F. Type 8-71	160 to 360 meters.....	4
R. F. Type 8-80	A long wave transformer that will operate at maximum amplification at 300,000 cycles.....	7

TYRMAN ELECTRIC CORPORATION

141-143 West Austin Avenue

Chicago, Illinois

MEMBER  MEMBER

are mounted on solid brass brackets. Another extremely important feature heretofore unused, is the new type of clutch which assures perfect concentricity. Provisions are made for single and double control tuning systems.

New Line Includes a Shielded Socket

The Tyrman Shielded Socket is designed to give each tube the chance of proper functioning in hook-ups under the influence of magnetic and static fields. This idea was accomplished to a cer-

tain degree by some manufacturers in the past, but the Tyrman Electric Corporation presents a practical unit which would need no alterations in amateur built sets. These sockets mount with one screw and can be used with sub-panel or baseboard mountings. Heavy aluminum stock is used for the shielded part, it being the best heat conductor obtainable and will keep the temperature of the tube constant. It will greatly help in stabilizing the circuit, eliminating whistles, howls and microphonic noises.

Tyrman Electric Corporation

Exclusive Distributors for
Kurz-Kasch Capacity
Connector

The Kurz-Kasch Capacity Connector is destined to revolutionize set-building possibilities. It eliminates 90% of the wiring and acts as a by-pass condenser between all battery leads. Because of the difficulty to adapt most of the standard radio parts to this item, the engineers of the Tyrman Electric Corporation constructed their entire apparatus to fit the terminals of this connector. Thus they are today the only manufacturers who are building radio parts to a definite standard. It is certain that this innovation will create a sensation among the set building public.

Jobbers and Dealers

Backed by the enviable reputation of their designer and by a comprehensive advertising and merchandising campaign, Tyrman Products offer Set Builders, Dealers and Jobbers a splendid profit opportunity. T E C Products all carry an unconditional guarantee of excellence assured by rigid and exhaustive Laboratory tests.

Complete descriptive literature will be sent to Jobbers and Dealers upon request.

Set Builders

To fully acquaint yourselves with Tyrman Products, send for special booklet, describing T E C Parts in detail. Ask to have your name placed on our mailing list that you may receive advance information of the latest developments in our laboratory. This incurs no obligation on your part.

Mail This Coupon

TYRMAN ELECTRIC CORPORATION
141-143 W. Austin Avenue
Chicago, Illinois

Gentlemen:

Kindly send to me, gratis, special booklet describing T E C Products in detail. Place my name on your mailing list that I may receive advance information of new developments in your laboratory.

Name.....

Address.....

State.....

Jobbers Name.....

Address.....

Camfield Super-Selective "9"

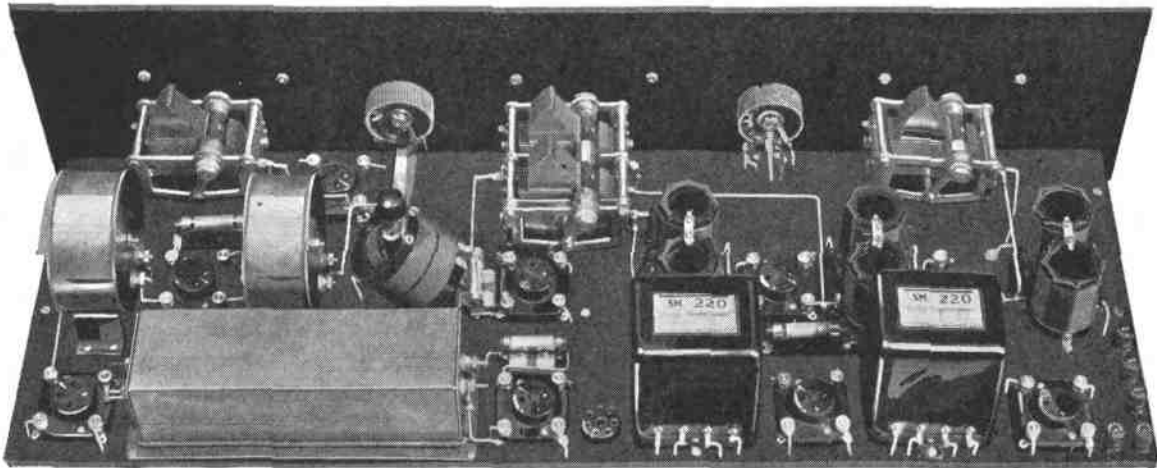

Using the famous
RUSCO 10 KC BAND PASS FILTER
 IS THE OUTSTANDING CIRCUIT FOR 1927 - 28

THE GREATEST RECEIVER EVER DEVELOPED

The circuit uses many features of proven merit never before incorporated in a Radio receiving set. These features result in an outstanding achievement, namely: the simultaneous increasing of both selectivity and sensitivity to a point heretofore considered impossible.

Complete descriptive articles on this remarkable new circuit will appear in early Fall issues of "Radio," "Citizen's Radio Call Book," "Radio Age," "Radio Review and Listeners' Guide," "Western Radio Trades" and other magazines. Similar articles will also appear in the New York Sun, the Chicago Evening Post and many other leading newspapers throughout the country.

Camfield EQUALTUNE CONDENSERS

Unequaled for

ACCURACY
 MECHANICAL DESIGN
 ELECTRICAL EFFICIENCY
 WORKMANSHIP
 APPEARANCE
 GENERAL UTILITY

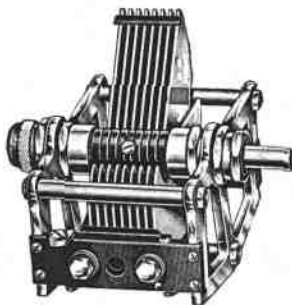

Manufactured in

ALL POPULAR CAPACITIES
 AND IN UNITS OF
 ONE TO FIVE GANGS.
 ESPECIALLY ADAPTED
 FOR USE WITH THE
 NEW TYRMAN DRUM DIAL.

"A TRIBUTE TO A LEADER"

Camfield Equaltune Condensers are the unanimous choice of discriminating manufacturers, jobbers, dealers and set builders. There is proof of this in the fact that they are being officially specified in the following circuits for the 1927-28 season:

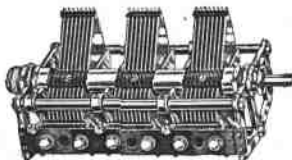

Camfield Super-Selective 9.
 The Flewelling Super Ten.
 Scott's Worlds Record Super 10.
 Madison Moore Super.
 Madison Moore AC Operated Radio
 Frequency Circuit.

The New St. James U240.
 Camfield Duoformer 5.
 Eight-in-Line.
 Hagerman's Organtone.
 And many others.

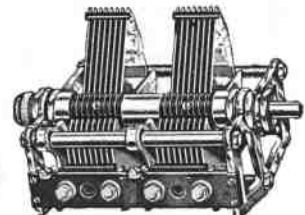

Jobbers, Dealers, Set Builders and Set Manufacturers!

Write for Detailed Information

CAMFIELD RADIO MANUFACTURING COMPANY
 351-363 EAST OHIO STREET, CHICAGO, ILLINOIS



Tell them that you saw it in RADIO



The
Watch Dog
of Your
Tubes

PERFECT Tube Performance demands **AMPERITE**

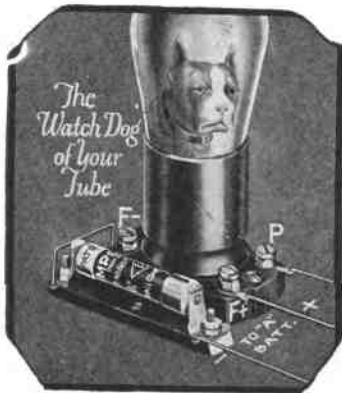

FREE — Write for
"The Radiall Book"
containing the latest popular
Hook-Ups and Construction
Data, to Dept. K-7

NO tube is better than its filament regulation. And Amperite alone guarantees that perfect regulation required to bring the utmost in clarity, volume and tone quality out of your tubes.

With Amperite you can forget both tubes and rheostats. At all times—under every varying battery condition—this variable tube filament current resistance works automatically, eliminating hand rheostats and rendering

every tube fool-proof against damage and premature burn-outs. If you want Amperite performance — insist upon Amperite. Don't be misled into buying substitutes represented as just as good. There is only one Amperite — and nothing else will do. Approved and specified by leading engineers in every popular circuit.

Types for every tube and battery. Sold everywhere. Price complete with mounting \$1.10 (in U. S. A.)

Radiall Company

52 FRANKLIN STREET, NEW YORK

AMPERITE

REG. U.S. PAT. OFF.

The "SELF-ADJUSTING" Rheostat

Tell them that you saw it in RADIO

LEUTZ

UNIVERSAL TRANSOCEANIC

9 TUBES

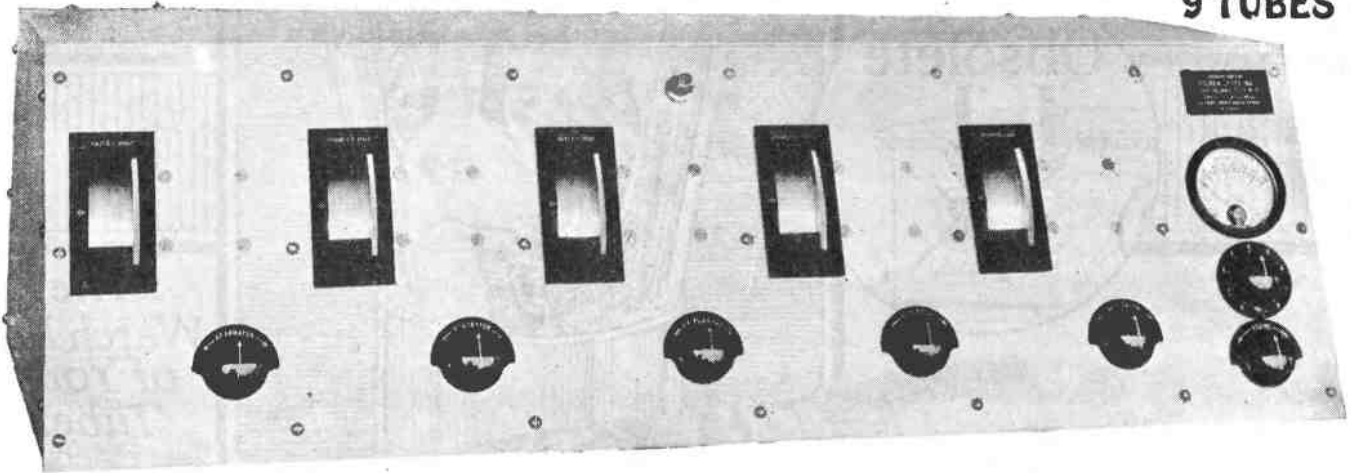

TRUE SELECTIVE POWERFUL

NEVER before has any radio ever provided at so low a price, so many QUALITIES and exclusive features. Modern to the minute in design, offering True distinction in appearance, built of fine materials, master workmanship, — the "UNIVERSAL TRANSOCEANIC" is the outstanding triumph of the most favorably known builders of powerful radio receivers.

Write For Our New Literature Today.

C. R. LEUTZ, Inc.

Sixth and Washington Aves., Long Island City, N. Y.

NOW

\$150

DIRECT

FROM OUR FACTORY

TO YOU

QUALITY AT LOW COST

You Can't Carry a Load of Hay on a Wheelbarrow



NEITHER can you obtain good musical performance from your receiver unless your audio amplifier can carry the full load of rich tones and overtones.

Wherever tone quality is paramount you will find Thordarson Amplifying Transformers. Over thirty manufacturers of leading quality receivers use them as standard equipment.

Follow the lead of the leaders. Whether buying or building a receiver—if you enjoy music—insist on Thordarson Amplification.

You don't have to be water boy to the

THORDARSON BATTERY CHARGER



DRY—As dry as they make them. In fact the rectifying element is contained in a moisture-proof cartridge.

SILENT—No vibrating parts. Current is rectified through a patented electro-chemical process.

SAFE—There is no hazard to rugs or woodwork for there is no acid to spill. The tubes of the set are safe, even if turned on when the charger is in operation.

COMPACT—Fits into battery compartment easily. Only 2¾" wide, 5¾" long and 4¾" high, overall.

EFFICIENT—This charger is always ready for service. No overhauling required. Rectifying element is held in spring clips and can be replaced in thirty seconds.

LONG LIFE—The Raytheon rectifying unit used in this charger is guaranteed by its manufacturer for 750 hours of full load operation, or approximately one year's service. The transformer will last indefinitely.

CHARGING RATE—2 amperes.

Price \$12⁵⁰



THORDARSON Power Compact

The only complete foundation unit for home-built power amplifiers. Contains power supply transformer, 2 30-henry choke coils, 2 buffer condensers and center tapped filament supply—all in one compound filled case. Supplied in two types: R-171 for Raytheon rectifier and UX-171 power tube, and R-210 for UX-216 B rectifier and UX-210 power tube.

Type R-171, \$15.00

Type R-210, 20.00



THORDARSON R-200 Amplifying Transformer

A transformer designed for the musical epicure. The large core of finest silicon steel and the high inductance primary winding combine to give this instrument the most perfect transformer reproduction obtainable. Has a remarkably wide range of amplification. Ideal for use with cone type speakers. Designed for both first and second stage amplification. Weight, 2 lbs.

Price \$8.00

THORDARSON

RADIO TRANSFORMERS

Supreme in Musical Performance!

THORDARSON ELECTRIC MANUFACTURING CO.
Transformer specialists since 1895
WORLD'S OLDEST AND LARGEST EXCLUSIVE TRANSFORMER MAKERS
Chicago, U.S.A.

3556

REMLER REMLER REMLER

PARTS THAT IMPROVE RECEPTION in any Circuit

REMLER Radio-Frequency AMPLIFIER

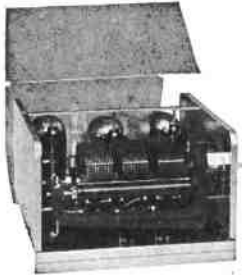

A copper shielded, single-dial control, front end, completely wired. Its use eliminates the difficulties common in radio construction. A compact unit incorporating two stages of radio frequency and detector. Can be adapted to any tuned radio frequency circuit. The use of this radio frequency amplifier in the Infradyne circuit assures wonderful results.

The Antenna Compensator, which is included, permits complete equalization.
No. 710.....Price \$55.00
(Ready for delivery August 1, 1927)



Antenna Compensator

REMLER Infradyne FOUNDATION KIT

This Kit contains all that is needed for the construction of the Infradyne Receiver except the transformers, voltmeter, Infradyne Amplifier and Cabinet.

No. 750.....Price \$52.00
(Ready for delivery August 1, 1927)

REMLER Infradyne CABINET AND BASE

The cabinet is pure sheet copper, embossed in two-tone brown crystal lacquer with a decorated wood base size 11 x 26.
No. 760.....Price \$15.00
(Ready for delivery August 1, 1927)

REMLER Drum DIAL



The Remler Drum Dial gives a full 15 inches of dial space, divided into 200 divisions—2 for each broadcast channel.

Calibration strips are rigidly mounted.

Socket and 6-volt lamp furnished for illumination. Easily mounted; round drilled hole required for panel plate.

The Remler Drum Dial will drive all standard makes of condensers either single or in gangs of one, two or three condensers.

Right or left hand mounting.
No. 110. Price.....\$4.50

REMLER Infradyne AMPLIFIER

A three-stage radio frequency unit which is adapted for use in connection with practically all standard sets of the tuned radio-frequency or neodyne types, and which also fully meets the requirements of the Sargent Infradyne Circuit. It is designed to employ tubes of the CX-299 or UX-199 type.



No. 700. Price.....\$27.50

REMLER 3-in-Line CONDENSER

The new Remler Three-in-Line Condenser offers definite advantages found in no other gang condenser. Complete insulation of each rotor permits its use in any system of neutralization.



Balancing Condensers are quickly adjusted by means of conveniently located regulating screws. Ample space is allowed between sets of plates. Frame is die-cast aluminum with black crystalline enamel finish.

Special staggered connection of plates makes it self-shielding, preventing interstage coupling. All insulation is of genuine Bakelite. Maximum capacity of each section, .00035 mfd.
No. 633. Three-in-Line Condenser. S. L. Wave Length.....\$15.00
No. 643. Three-in-Line Condenser. S. L. Frequency..... 15.00

REMLER Twin-Rotor CONDENSER

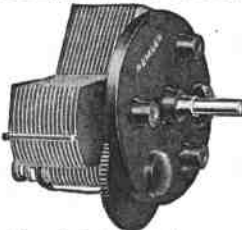

Rotation of the dial through a full 360° gives greater separation of stations at all wave lengths than is possible with the usual 180° dial. A special adjustment which permits variation of the condenser capacity at zero dial setting allows a still further spreading of the stations in the Straight Line Frequency type.

Straight-Line Frequency

This type gives the greatest possible separation of stations over the entire broadcast band. Equal divisions on the dial represent equal frequency bands.
No. 648—.00035 max.....\$5.00
No. 649—.0005 max..... 5.00
No. 659—.0001 max..... 5.00

Straight-Line Wave Length

This type should be used to separate to the greatest extent the long-wave Class "B" stations. Equal dial divisions represent equal wave-length bands.
No. 638—.00035 max.....\$5.00
No. 639—.0005 max..... 5.00

REMLER 2-in-Line CONDENSER

The Remler Two-in-Line Condenser is identical in construction and design with the Three-in-Line described above except that it is of two-gang type.

Maximum capacity of each section, .00035 mfd.

No. 632. Two-in-Line. S. L. Wave Length\$12.00
No. 642. Two-in-Line. S. L. Frequency 12.00



REMLER Improved SOCKET

The No. 50 Remler Socket is designed for use with X-type, standard base tubes. Positive contact is insured by brass contact levers extending the full length of the tube base prongs and held under firm pressure by high tension springs.

No. 50. Price.....\$0.50

REMLER

Division of

GRAY & DANIELSON
MANUFACTURING CO.

260 First Street
SAN FRANCISCO

CHICAGO

NEW YORK



REMLER Choke COIL

The No. 35 Choke Coil is of distinct utility in limiting radio-frequency currents to certain paths and in preventing the generation of high parasitic frequencies.

No. 35. Price.....\$0.80

REMLER REMLER REMLER

Absolute reliability at last!



Universal Socket Power Units Built to excel — not undersell

Everyone wants power from the light-socket; so almost every radio manufacturer is ready to supply some sort of unit to furnish it.

But the supreme test of the scores of Socket Power units on the market is **reliability!** Nothing else is worth having for a moment.

For many months Universal has been experimenting, rejecting, selecting, to choose the parts which make up the A, the BC and the ABC units shown. Into their building has gone all the experience gained in over a quarter of a century of fine battery making.

There is no guess-work here. No skimping of quality to meet a price. Performance alone has been the goal.

Make Universal your choice, and you can then forget entirely about the source of your radio power.

THE UNIVERSAL BATTERY CO.

3458 So. La Salle Street, Chicago

BATTERIES FOR EVERY PURSE AND PURPOSE

UNIVERSAL BATTERIES

Tell them that you saw it in RADIO

Dealers! Jobbers!

Those of you who respect your trade and who value good will are going to have a mighty profitable season selling Universal Socket Power units. We'd like to put our selling plans up to you together with our new discount sheets and complete specifications of the three units.

The A unit is equipped with Westinghouse Rectox dry plate rectifier controlled by set switch. Has B plug-in. The BC unit delivers 40 mils. at 180 volts. Ideal for 171 power tube operation. Guaranteed delivery of proper voltages to each tube as specified by set manufacturer. Seven taps — two for C voltages and all variable due to the use of wire-wound resistances throughout. Improved filter circuit. Designed for use with Raytheon BH-85 mil. long-life rectifying tube. Raytheon approved. Operates perfectly on any set.

The ABC unit is a combination of the above two, all contained in one case. Set switch controls it.

All cases furnished in attractive brown, crackled lacquer finish.

Send for full information without delay: There's no obligation.



Dongan Laboratories Again Shares Honors in New Power Eliminator Achievement

The announcement by the Raytheon Laboratories of the perfection of the B A 350 m.a. rectifying tube for the elimination of A, B and C batteries signifies one of the greatest steps forward to the general use of radio that has yet enthralled the eager fans. Until radio became so simple that easy and certain success could be assured without the annoyance of cumbersome and complicated power accessories, many folks were not inclined to make the effort. However with the simplicity of Raytheon's new invention the power difficulty of successful radio reception becomes as antiquated as hand-cranking your automobile.

It is only natural that the Dongan Electric Manufacturing Company of Detroit should participate in the practical working out of this radio achievement. According to G. J. Scherling, secretary and treasurer, Dongan has laid particular stress on research and experimental work for several years, in fact ever since it became evident that the public intended to make wireless a huge commercial undertaking. From the very early days of popular radio Dongan engaged exclusively in the design and production of radio transformers, at first audio transformers. Many of the leading radio receivers for years have been equipped with Dongan Audio Transformers.

As it became evident that a substitution for batteries must be found before radio would meet with the unanimous approval of the fans Dongan, together with several other radio pioneers, developed a definite plan for experimental work. That this department of the Dongan organization has accomplished its purpose is clearly evidenced in the gradual elimination of battery devices until today there is no further need for any battery power other than that available from the light socket.

In each new development Dongan has played some part. Today many of the leading B-eliminator manufacturers use Dongan Special Transformers as standard equipment. It is significant of Dongan's policy, that, throughout this period, Dongan has refused all the tempting opportunities that naturally have come its way in the course of research and development. At no time has Dongan considered manufacturing and marketing a Battery Eliminator of its own but has been content to co-operate with and serve those worth-while manufacturers of complete outfits who have concentrated in this field. Dongan has continued to design and build radio parts exclusively. The new

Power Transformers for use with Raytheon's new rectifier tube were developed together with Raytheon engineers and, of course, are approved by Raytheon Laboratories. Used with the regular 201 A tubes Dongan No. 3591 Transformer has 700 volts center tap 300-400 mills and 5 volts 1/2 amperes. Dongan Double Choke No. 3584 is designed for 300-400 mills.

The transformer is substantially built into a good-looking metal case and will give indefinite service. This also applies to the two chokes included likewise in an attractive metal case. For set manufacturers these models can be built unmounted.

Lyle Hicks, president, says that samples can be had at once and that the factory expects to be in full production within a few weeks.



What The New Sets Will Include!

More, even, than in previous years Dongan Parts will be identified with the season's leading receivers and power units.

New designs in audio transformers and power unit parts are now available. Manufacturers who are designing sets to use the new Raytheon B A 350 m.a. tube can secure immediate delivery on Raytheon-approved transformers and chokes.

Individual Set Builders

No. 3591 Transformer and No. 3584 Double Choke are used with the new Raytheon B A 350 m.a. rectifier tube. A unit built up with these parts does away with all batteries and other power accessories. Better and much more satisfactory radio reception can be had now by plugging into a light socket for A and B power.

You can modernize your own set at slight cost and an eventual saving. The Raytheon B A 350 m.a. tube at \$7.50 list, as well as the Dongan No. 3591 Transformer, \$15 list, and No. 3584 Double Choke, \$15 list, can be had at once by sending check or money order.



No. 3591 Transformer in handsome and durable metal case—available also in unmounted types.

List \$15



No. 3584 Double Choke (2 chokes in one case)

List \$15

Raytheon B A 350 m.a. Tube

List \$7.50

DONGAN ELECTRIC MANUFACTURING CO.
2981-3001 FRANKLIN STREET, DETROIT

TRANSFORMERS of MERIT for FIFTEEN YEARS

Sentinel—

The First and Only Complete Line of Radio Power Units

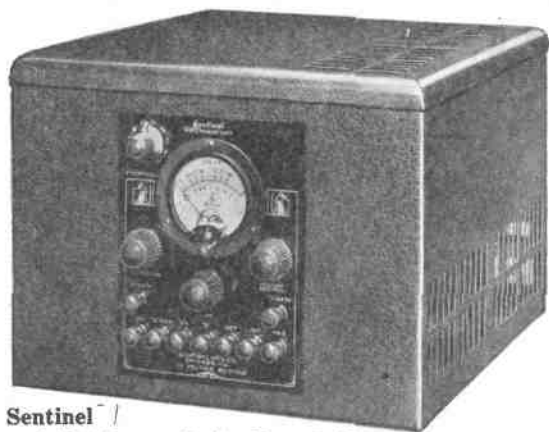

Sentinel /
A-B-C Power Unit—Beverly Model

The most elaborate descriptions of these units would fall far short of doing justice to the importance they hold in the radio world. They are the first and only completely automatic power units. In the "Beverly" model pictured on the left, equipped with volt meters which allow perfect control of all plate voltages, the set owner has everything he could desire for power operation of ANY receiver.



Beverly Model

\$65



Sentinel
B-C
Power
Units

\$44.50

Beverly Model and Regular Type
Furnishes "B" and "C" Current for ANY Radio Set—
80 Mil. drain at 180 Volts with Ample
Reserve Power

—for every Radio Power Need

The Sentinel line is complete. It provides for every electrical need of Radio. For the set owner who uses a storage battery and wants automatic "A" power, we have perfected the automatic Relay and Charger; if he has a good charger, the Automatic Control Unit alone will answer his purpose. The Sentinel Automatic "A" Unit provides relay, charger and "A" battery all in one compact case. The Sentinel "B-C" unit furnishes "B" and "C" current for ANY set made with ample reserve power. It has an 80 mil. drain at 180 volts. Going still a step further, the Automatic Relay, Charger, "A" Battery, and B-C unit are scientifically combined into one master unit for all radio power purposes—the Sentinel A-B-C.

There is nothing on the market to compare with Sentinel products. They are absolutely unique—and their perfect performance is guaranteed. Our extensive schedule of forceful marketing and advertising has started. Eighteen branch offices assure jobbers of unusual service and co-operation. Write for all the facts.

SENTINEL MANUFACTURING CO.
9705 Cottage Grove Ave., Chicago, U. S. A.



Sentinel \$15
Automatic Control
Makes Your "A" Battery
and Charger Completely
Automatic



Sentinel \$29.50
Automatic Control and Charger
Makes Your "A" Battery a
Completely Automatic Power
Unit



Sentinel \$79.50
A-B-C (Completely Automatic) Unit Supplies
Every Power Requirement of Radio



Sentinel \$40
"A" Completely Automatic
Power Unit
Not a Trickle Charger

MR. RADIO EMPLOYER!

Do You Need Some Good Men?

Radio employers who wish to make additions or replacements within their organizations should call on our Free Employment Service for assistance. Men usually available at any point in the United States or Canada on 48 hours notice. There is absolutely no charge for this service, either to the employer or to the employee.

We can supply men qualified for work in manufacturing plants, research and designing laboratories, or broadcast stations; licensed men for commercial land and sea operating jobs; Radio-trained salesmen for the manufacturer, jobber, or retailer; men who are competent at Radio service, installation, construction, and repair.

If you need a trained Radio man for any kind of work, or if you expect to need one in the near future, see if we can't help you. Write, describing the position and the sort of man you desire. You'll be informed promptly if we have available the man you need. Address correspondence to M. B. Taylor, Manager, Employment Department, National Radio Institute, Washington, D. C. A free monthly bulletin, listing men available and their qualifications, is published by this department. Your request will bring it to you regularly. Please refer to "RADIO."

(We conduct the oldest and largest Radio home-study school in the world, and our students and graduates are to be found in almost every Radio organization of importance. Our course of practical training is recognized by the U. S. Government, which allows our graduates the customary points of credit toward any Radio license they may wish to take out. See announcement on opposite page.)

Want More Money?

You Can Increase Your Earning Power
by Learning More About Radio

If you're making a penny less than \$50 a week, you're not getting what you ought to get out of Radio.

Thoroughly - trained men — men whose knowledge of Radio is completely rounded out on every point—earn all the way up to \$250 a week.

Radio is a new industry with plenty of fine positions unfilled. There are countless opportunities in Radio for a man to earn a splendid salary. But these are not opportunities as far as you are concerned, unless you're fully qualified for them.

The only way to qualify is through knowledge — training — practical, complete training, that fits you to get and to hold a better position in the Radio field.

See If This Free Book Can Do You Any Good

I publish a 64-page book, printed in two colors and filled with facts and photos relative to Radio and its opportunities.

I don't say this book will help you, but it **does help** such a large percentage of those who read it that I can afford to send it to all who ask for it—free. You may get only a single idea out of this book that will be of any value to you. Or every line of it may give you a message.

A message to men now in the Radio business. And another to men who would like to be in.

I have helped all sorts of men to advance themselves in Radio.

Lots of them, men who knew absolutely nothing about Radio when they first wrote me. Some who didn't know the difference between an ampere and a battle-axe.

Others, graduate electrical engineers who wanted special work in Radio. Licensed sea operators who were way behind on the "BCL stuff." "Hams" by the score.

Last but not least, the service and repairman or salesman who wanted to advance or go into the Radio Business on his own. And the man already in on his own, who wanted to look forward to a more solid and permanent Radio future.

My Free Book—see coupon below—tells about my helpful methods, and cites the experiences of a hundred men—giving photos and addresses.

At any rate, fill in the coupon below and look it over. It costs you nothing but a two-cent stamp, and you place yourself under no obligation. I won't even send a salesman to call on you.

And there's always a chance that that two-cent stamp may make quite a difference in your future.

What My Radio Training Is

Under my practical system, a man can study at home in his spare minutes, and get a thorough, clear, practical and expert knowledge of Radio in from 4 to 12 months. The time required depends on his previous knowledge, his ability, and the time he can spare for study. He keeps right on with the job he has—no necessity for his leaving home or living on expense.

Then as soon as he's ready for a better position I'll help him to get it and to make a success of his work. See announcement on opposite page.

This proposition is open to anybody who is not satisfied with his job, his prospects, or his Radio knowledge. Regardless of how much you know already (or if you don't know the first thing about Radio technically) I'll fit my methods to suit your needs.

If you want to enter into any correspondence about your own situation, anything you write will come directly to me and will be held strictly confidential.

Tear the coupon off now before you turn the page, and mail it today.

J. E. Smith, President

NATIONAL RADIO INSTITUTE
Washington, D. C.

Oldest and Largest
Radio Home-Study
School in the World

Originators of
Radio Home-Study
Training

J. E. SMITH, President,
National Radio Institute,
Dept. GB-55, Washington, D. C.

Please send me your free book about the bigger opportunities awaiting the thoroughly trained Radio man. At present I (am) (am not) in the Radio business.

Name.....

Address.....

Town.....State.....

Tell them that you saw it in RADIO

CARTER PROGRESSIVENESS

THE CARTER RADIO COMPANY was one of the pioneers of the industry and its growth has been steady.

Radio in the early stages was mostly a proposition of make-shifts. It was more or less a new art although the reproduction of voice had for years been studied by telephone engineers. It was natural, therefore, that the first parts used in this new art should be adapted from the older arts of the telephone and telegraph.

The Carter Radio Company, however, realized that make-shifts were nothing but make-shifts and that radio art as it developed would require items new and original and peculiarly adapted to the art for its perfection.

All the Carter parts, therefore, are original and exclusive, in their design, their engineers setting about to discover the problem and then building a part to meet the condition presented.

It is not surprising that a firm as progressive and as keenly alert to the demands of radio progress should have originated and manufactured so many new and individual products.

It is not surprising under these conditions that in an industry more or less saturated with mushroom growths the Carter Radio Company is one of the phenomenal successes.

It has been truly said there is no substitute for a Carter part and you can readily see why.

Radio engineers who design the popular circuits turn instinctively to Carter parts, realizing that in them they can place the utmost confidence that the part will perform consistently and assure the success of the circuit.

The progressive spirit of the Carter Radio Company has been shown not only in their designing and manufacturing departments but also in their executive departments. The Carter Radio Company has offices in the principal cities of the world. Besides their modern, up-to-date factory in Chicago, there

is also a Canadian factory to take care of Canadian business and in the east at Bridgeport, Conn., plants are busily engaged in turning out Carter parts. This insures prompt shipments to all parts of the country.

Manufacturers appreciating Carter quality and originality of design have been quick to incorporate Carter parts in their sets.

Mr. A. J. Carter, President of the Corporation, realized from the first the necessity for standardization of parts and as chairman of the standardization committee of the Radio Manufacturers Association has contributed much to this work. He has practised what he has

preached with the result that in the Carter plants standardization has been carried throughout the complete line.

Among the new Carter items available are: a complete new line of molded mica condensers, by-pass and filter condensers, resistors for A. C. operated sets and "B" eliminators, 110 volt switch, new receptacle outlets, new heavy duty rheostats and potentiometers.

Ever alert, ever keen to anticipate the requirements of the industry it is not surprising that the Carter Radio Company is continually each season, bringing out new items which are regarded by those in the industry and those interested in radio as epoch-making.

CARTER PARTS

Largest line of up-to-date
Radio products made

SPECIFIED
in all popular circuits.

Complete line of:

JACKS	RESISTORS
PLUGS	ADAPTERS
POTENTIOMETERS	FILAMENT SWITCHES
JACK SWITCHES	RECEPTACLE OUTLETS
110 VOLT SWITCHES	PILOT LIGHTS

RHEOSTATS
with or without Filament Switch

VOLUME CONTROLS
with or without Filament Switch

VOLTAGE CONTROLS
for "B" Battery Eliminators

New line of Fixed Condensers

Each part is developed from original research: it is original in design, new in conception and built to meet a specific requirement.

In Canada: CARTER RADIO CO., Limited, Toronto

Offices in Principal Cities of the World

Carter Radio Co.
CHICAGO

MEMBER
RMA

Raytheon *Leads*



Raytheon BA
350 m. a.
(Half size)

Raytheon's leadership in the rectifier field is demonstrated again by the announcement of these sensational new rectifiers, worthy to take their places alongside Raytheon Types B and BH.



Raytheon A
2 1/2 amps.
(Actual size)

Light Socket A-B-C Power With One Rectifier

By this amazing rectifier, Raytheon BA-350 m. a., the final great step in the development of radio power is accomplished. Compact, built-in A - B - C power, without accessories, becomes a fact.

Soon a specially selected group of leading radio manufacturers will announce their newest receivers, using Raytheon BA-350 m. a. Standard 201-A tubes are used, and all batteries, chargers, accessories, and outside power equipment are eliminated.

Raytheon BA-350 m. a., the crowning accomplishment of the Raytheon Research Laboratories, has at last given the radio world a practical, proven solution to the problem of simple light socket receiver operation.

A Revolutionary Scientific Achievement

In High Current, Low Voltage Rectification Raytheon A-2 1/2 amps. is revolutionary in principle, in construction, in performance. It is an unbreakable metal cartridge, compact and simple, without liquids or filaments.

Above all, it is The Efficient Rectifier. Its operating cost over the period of a year, compared with that of other types of rectifiers designed for similar uses, will show a cash saving of many dollars.

Raytheon A-2 1/2 amps. was invented by Monsieur André of La Radiotechnique in Paris, and developed by the Raytheon Research Laboratories with his co-operation.

Battery chargers and A power units using this remarkable rectifier will bear the same seal of approval that distinguishes all Raytheon-equipped power devices.

RAYTHEON MANUFACTURING COMPANY

Cambridge, Massachusetts



Only manufacturers whose units have been tested and approved by Raytheon may use this seal on their products.

New Prices

Type B . . .	\$4.50
Type BH . . .	6.00
Type BA . . .	7.50
Type A . . .	4.50

Raytheon

The Heart of Reliable Radio Power

Tell them that you saw it in RADIO

MILESTONES OF PROGRESS

The progress of an enterprise from small beginnings to a successful and well known establishment is always interesting. It is interesting to those energetic and ambitious young men who still have their way to make and to whom such a history is both an encouragement and a lesson—for we all really learn best by example. It is just as interesting to those who have already made their mark, for purposes of comparison.



First National Co.
Factory, 1914

The story of the advancement of the National Company, Inc., of Malden and Cambridge, Mass., from its first and small beginnings along the milestones of its progress, to its present, well recognized place in industry, starts in 1914. It occupied at that time a small space in Boston, Mass., of 20 by 20 ft. One of its products at that time has since become famous, for "Ragtime Rastus," the little phonograph dancer that has given joy to so many thousands of children, made his first bow to the public at that time from the doors of the National Company. "Ragtime Rastus" danced his way out of the National Company factory to fame, and since then has been booked many times in moving pictures. Many of our readers have probably seen "Ragtime Rastus" when he supported Mae Murray in a feature production. Mr. William A. Ready, the present President and General Manager, was in charge of National Co. at that time.

In 1917 the Company moved to larger quarters and went into the manufacture of thread gauges and airplane parts for the United States Government. It continued in this essential industry throughout the period of hostilities, and was later awarded a Distinguished Service Certificate for War Services rendered.

With the return to peace-time activities, the Company went into the manufacture of equipment for the construction of large power houses, including safety cell doors, for switch and bus compartments, illuminated gauge glasses for power boilers, and other items of that character.

This business grew with sufficient speed to warrant the purchase in 1920 of a two-story brick factory at No. 110 Brookline Street, Cambridge, containing 11,500 square feet of floor space. The Company continued with the manufacture of its power-house-equipment items and added a small building of 8,400 square feet in the rear for enameling ovens, etc.

In 1922 the National Company entered the Radio field, and in that year first made the NATIONAL VARIABLE CONDENSERS and the original NATIONAL VELVET VERNIER DIAL Type "A" with its well known planetary friction gearing. These items gained immediate popularity—the VERNIER DIAL being among the very first of that type to be introduced.

In 1923 the present NATIONAL Type DX Condensers were first brought out, and also the NATIONAL Transmitting Condensers, for the use of broadcast stations and "Hams." These are now in use all over the world.

The year 1924 was marked by an important and significant milestone for the National Company, for in that year, Glenn H. Browning, then a graduate student at Harvard University, first came to the attention of Mr. Ready. He had been conducting some research work for a thesis with F. H. Drake on a Radio-Frequency Transformer with high gain. The research had worked out very successfully and Browning had built a set employing the new coils which had been designed. Mr. Browning talked, at about this time, with Mr.

Gordon who was advertising manager of the Atlantic Radio Company of Boston, and Mr. Gordon was sufficiently interested to visit Browning's house and listen to the set. The following day, Mr. Ready happened to go into the Atlantic Radio Company on some business, and Mr. Gordon enthusiastically described the performance of the new set to him. At this psychological moment, Browning himself entered the Atlantic Radio Company and was introduced to Mr. Ready.

The result of the following conversation was that Mr. Ready, with his associates, visited Browning's house that evening and heard the set. Although the original research had been done without any thought of commercial development, the possibilities seemed so good that the National Company went into the manufacture of the essential transformers, combining them with their NATIONAL CONDENSERS and VELVET VERNIER DIALS, to form the first NATIONAL Tuning Units. Although the new product moved rather slowly at first, it rapidly gathered headway and a large demand soon arose. And there have been probably more Radio sets built in the United States using NATIONAL Tuning Units than any other type of home-built receiver.

In 1924 and 1925 National Company developed and brought out its "B" type of VELVET-VERNIER DIAL, to meet the popular demand for a slow motion tuning control, to be fastened to the front of a panel and of the window type. This same year, the NATIONAL IMPEDANCE FORMERS were put on the market—among the very first units for the construction of impedance audio amplifiers—now so deservedly popular for their fine tone quality.

During 1926, Mr. Ready still further expanded the Radio line of the National Company, by the development of the ILLUMINATED DIAL, and in the Fall, the production of Transformers, Chokes and Condenser Blocks, for plate power supply.

In addition, National Company first sold a completely wired and ready-to-operate, heavy-duty B-Power Supply Unit, and a three-stage Power Amplifier combined with a B-Supply Unit, known as the NATIONAL POWER AMPLIFIER.

By the beginning of 1927, the Brookline Street building in Cambridge, was so crowded that it was imperative to seek for larger space, and a new and much larger factory building in Malden, Mass., was bought. At the same time this building was purchased, the new NATIONAL Tuning Units were brought out with the OFFICIAL BROWNING-DRAKE R. F. TRANSFORMERS and COILS, and the new NATIONAL EQUITUNE CONDENSERS with their structural girder frame type of construction. And, latest of all NATIONAL products, the NATIONAL FULL WAVE DUO RANGE CHARGER, which uses the new Raytheon "A" Rectifier, is just now announced to the public.

Thus equipped with two plants with a total floor space of 39,500 square feet, the National Company is prepared to enter the Radio field for 1927-8 with full facilities for quantity production.

And in the span of its existence from 1914 to the present time, its good name and good will have been built up, together with its national distribution, so that it occupies an excellent position in Radio—the newest of its lines—while still continuing the manufacture of its other lines of engineering specialties.



National Co. Factory at Brookline, Mass.
1920 to Date



National Co. New Malden Factory, 1927

— [NATIONAL COMPANY INC., W. A. READY, *President* CAMBRIDGE and MALDEN, MASS.] —

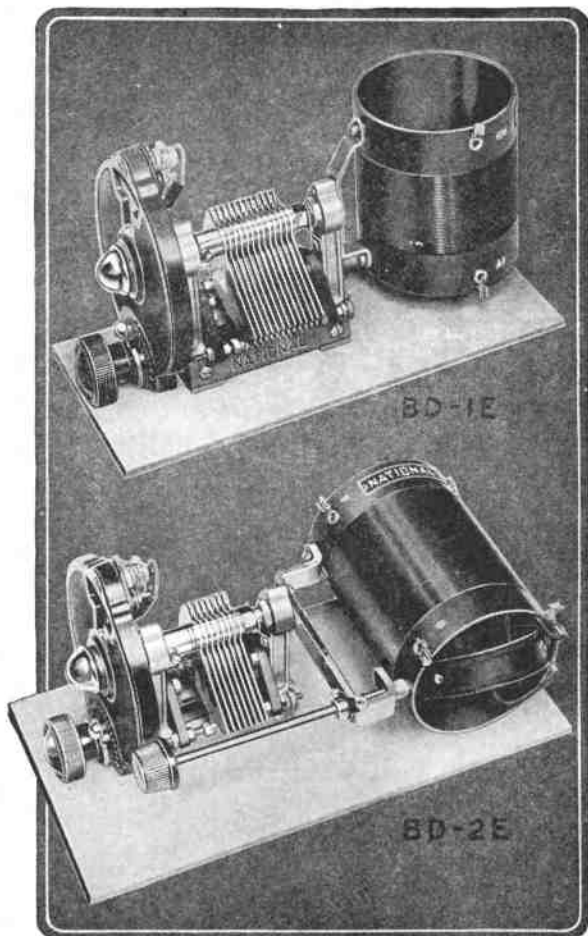

NATIONAL TUNING UNITS BD-1E AND BD-2E

A new type of these famous units
comprise the genuine and

Official BROWNING-DRAKE

R. F. Transformers and Inductances with slotwound primary and spacewound secondaries,—the new NATIONAL EQUITUNE Condensers with Girder Frames, and the NATIONAL ILLUMINATED VELVET VERNIER DIALS, Type "C". Each tuning unit separately mounted on heavy pressboard base in separate box, to be used on the base for experimental work or for easy attachment to any panel.

NATIONAL Tuning Units have been built into fine Radio Sets since 1924 and are officially approved by Glenn H. Browning.

Price BD-1E, with Genuine BD Antenna Coil and .0005 Condenser

— \$10.75 —

Price BD-2E with Genuine BD Transformer and .00025 condenser

— \$14.25 —

Deduct 50c each for dials without illumination



Come and see us at the
R. M. A. Trade Show
Stevens Hotel, Chicago
JUNE 13 - 18
and send for new pamphlets



The most widely used Illuminated Vernier Dial on the market. Its clear glow invites you to a quiet hour in your favorite corner. Variable Ratio 6-1 to 20-1,—beautiful Bakelite case,—easily attached by anyone.

ILLUMINATED
NATIONAL VELVET VERNIER DIAL

— Price \$3.00 Each —

Deduct 50c each for dials without illumination



A NEW Battery Charger without tubes or liquids, employing the new Raytheon "A" Unit and charging batteries at either 2 1-2 or 5 ampere rate as desired. Made to established NATIONAL COMPANY standards.

NATIONAL DUO-RANGE CHARGER

— Price \$19.50 Each —

BE SURE YOU GET THE GENUINE

NATIONAL

RADIO PRODUCTS

NATIONAL COMPANY INC., W. A. READY, President, CAMBRIDGE and MALDEN, MASS.

Tell them that you saw it in RADIO

American Transformer Company Ready for New Season with Proved Units



AMERTRAN radio products have been known in the United States for twenty-five years. They were used in 1904 for the Marconi tests across the Atlantic Ocean, and in 1927 in connection with the radio telephone service to England. AmerTran transformers have come to be universally known throughout the United States as the best in the country. For audio frequency amplification or operation of radio sets from alternating current power lines, AmerTran products have the well deserved name in the United States of producing results not obtainable by any other devices.

Until AmerTran DeLuxe audio frequency transformers were introduced, type AF 6 (first stage) and type AF 7 (second stage) had the name of being one of the finest audio frequency transformers in America. With the exception of AmerTran DeLuxe they are still the best value. Type AF 6 (ratio 5-1) and type AF 7 (ratio 3½-1) sell at \$5 each.

The AmerTran DeLuxe audio transformer produces absolutely faithful amplification with natural quality. When it is used with proper tubes and loud speaker and clear signals from the detector tube, it will produce natural volume over the entire audible range. Until you have listened to radio amplified by these transformers you have not heard the truest quality with ample volume. AmerTran DeLuxe transformers are made in two types for first and second stages and are sold at \$10 each.

Not content with making it possible to secure quality in the output of your radio set, AmerTran has produced a new transformer which makes it easy to eliminate B and C batteries by supplying noiseless rectified current from the alternating current lines. Full descriptive matter of circuits will be supplied upon request. AmerTran power transformer PF52 for

use on 110 volts, 50 to 60 cycles, \$18; for use on 220 or 230 volts, 50 or 60 cycles, \$35.

Amerchoke Type 854 is a scientifically designed impedance or choke coil of general utility, designed primarily for use in filter circuits. As an output impedance for by-passing direct current from the loud speaker it is just as efficient and more economical than an output transformer. When used with a 1 mfd. (or greater) fixed condenser, the tone quality equals that of the best output transformer. DC saturation is prevented by two adjustable butt joints in the core. Amerchoke Type 854, \$6.

AmerTran Resistor Type 400 is particularly well adapted for use across the output of high voltage filter circuits to act as a stabilizer and tapped potentiometer for obtaining various plate voltages and it is also useful for other purposes such as a multiplier for voltmeter, etc. It will withstand a current of 30 milliamperes continuously without undue heating in open air, but is not guaranteed for current in excess of this value.

Good quality reception can only be obtained from a radio receiver when each radio and audio tube is provided with a negative grid bias corresponding to its plate voltage as recommended by the tube manufacturer. The 1 mfd. by-pass condensers which are connected between the taps and negative A should be placed within the receiver proper and not in the B eliminator. In other words, a 1 mfd. by-pass condenser should be connected between the B plus terminal of each radio as well as each audio transformer and the filament of the tube ahead of it.

AmerTran Resistor Type 400 has a cold resistance of approximately 41,000 ohms across the two sections in series and contains eight solder terminals. Price, \$7.50.

AMERTRAN

TRADE MARK REG. U.S. PAT. OFF.



AmerTran DeLuxe audio transformers are guaranteed to amplify at 80% of their peak at 40 cycles, and their peak is above 10,000 cycles. Made for first and second stages.



The AmerTran power transformer type PF52 and the AmerChoke type 854 (illustrated) are designed for use in the construction of power amplifiers to operate with UX-216B and UX-210 tubes at their correct voltages, supplying A, B and C to the last audio, and B and C to the other tubes.

AMERTRAN RADIO PRODUCTS CARRY THIS GUARANTEE

“AmerTran audio transformers, regardless of type, are fully guaranteed against defects for a period of one year from the date of purchase, and will be replaced free of charge either through your authorized AmerTran dealer or direct, if defective for any cause other than misuse. The individual parts are each carefully tested and inspected before assembly and the complete transformer receives a most rigid inspection and test before being packed for shipment.”

This is the way the American Transformer Company has won confidence and wide use for its products. AmerTran DeLuxe audio transformers are recognized as reliable efficient units for improving the tone quality and tone range

of present sets and as the indispensable choice for new sets. Other AmerTran products have been adopted for power supply apparatus that on performance stand in the front rank of modern development.

Send for Booklet
“Improving the Audio Amplifier”
and other useful data, free

THE AMERICAN TRANSFORMER COMPANY
178 EMMET STREET NEWARK, N. J.

“Transformer Builders for Over 26 Years”

Announcement

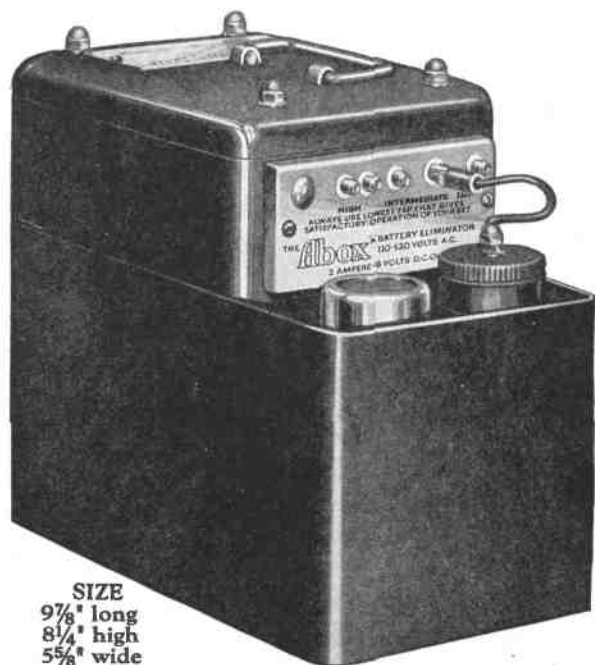

The **Abox** COMPLETE "A" Battery Eliminator Now Available

NOTHING ELSE TO BUY

Licensed by the ANDREWS-HAMMOND CORP.,
under Andrews' condenser and other Andrews
and Hammond Patents and Patent applications

The Best and Cheapest "A" Power

The Abox "A" Eliminator is a rectifier and an Abox Filter circuit in one compact unit. It changes the alternating current from the light socket to hum-free direct current for operating eight or less large tubes at 6 volts. Simply connect to any radio set without changing the wiring and turn the switch at the light socket.

It contains no batteries in paste form or otherwise. The same *condensers* that proved their efficacy in the Abox Filter are used in the Abox "A" Eliminator and supply the enormous capacities needed for a low voltage filter. These condensers cannot be punctured or broken down—they do not need replacing and their characteristics do not change with use or disuse.

The Abox will give the same long life and the same 100% customer satisfaction that the many thousands of Abox Filters now in use throughout the country have given in the past. It is fully guaranteed for one year *from the date purchased by the customer.*

Each part of the Abox "A" Eliminator is carefully designed and has been tested over long periods. Together they form a perfectly co-ordinated unit which is not only the *best* but the *cheapest* source of "A" Power for radio sets.

We will be pleased to furnish detailed information. Send for circulars or see us at the Abox booth and demonstration rooms at the RMA Trade Show, Chicago.

The ABOX Company

215 NORTH MICHIGAN AVENUE CHICAGO, ILLINOIS

RADIO

WITH WHICH IS INCORPORATED "RADIO JOURNAL"

VOLUME IX

JULY, 1927

No. 7

Radiatorial Comment

Although the framers of the new radio law purposely refrained from imposing any governmental censorship on radio broadcasting, aside from the prohibition of obscene or profane language, every station necessarily censors its own programs. This practice has been condemned, especially by some speakers who have been unceremoniously cut off in the midst of their remarks. But there is no legal question as to a station's right to thus protect itself.

Otherwise it may be liable to lawsuits for libel or slander. A number of such suits have already been brought on the basis that a station has the same responsibility as is imposed on a newspaper or magazine. Because of the difficulty in controlling radio utterances the libel laws may have to be modified.

But the main reason for station censorship is protection against a loss of audience. It is so easy for the listener to tune out anything to which he may object, that the stations take every precaution against the broadcasting of objectionable matter. This may be nothing worse than a tiresome or unpopular speech. Or it may be risqué remarks or seditious utterances. But in any case a station operator is required to listen to all that is said and is prepared to disconnect the microphone when the speaker or singer does not conform to the station's standards. Nor does it suffice to edit written speeches, for speakers do not always follow copy.

Station standards vary, just as do those of newspapers and magazines. Some allow only the most conservative and non-critical statements to be broadcast. Others are more liberal. Some allow no advertising. Others specialize on advertising. But as all are dependent for success upon having as large an audience as possible, the general policy is to hold that audience by not broadcasting anything that is objectionable to it.

Radio advertising, for example, was at first feared to be objectionable. Dire prophecies were made that it would kill public interest in broadcasting. But as a matter of fact it has been the salvation of good broadcasting. Without it there would be no adequate means of paying the fiddler. Every station today advertises something, even if nothing more than the name of its owner.

Nor, when we become accustomed to it, is there anything incongruous or shocking in radio advertising rightfully done. We are used to advertising in the newspapers and magazines and realize that their cost to us is a tenth of what it might be if there were no advertising revenue to pay the bills. How much more then are we of America indebted to the advertisers who make it possible for us to enjoy the finest music in our homes.

Furthermore, the advertisers have found this new

method of reaching the public ear to be most effective. They have an assured audience of possible buyers, whatever their product or service may be. This has been proved in almost every line of business. Though direct sales are seldom traceable, the beneficial results in creating new markets and in building good will are undeniable.

The only limitation is that the advertising must not be obnoxious. Just where to draw the line between the pleasing and the objectionable is difficult to determine. Even an ordinarily distasteful dish can be made palatable by proper seasoning. A super-program can stand more bally-hooing than a mediocre one. Yet more good will and more lasting results are created by a simple announcement that a program is presented through the courtesy of So-and-So than by expatiating upon the merits of a product and begging for letters and telegrams.

One fact that is evident in recent advertising via the ether is an improvement in technique. Much of the crudity that characterized early attempts has disappeared. The approach is more subtle, the pill is sugar-coated for easier swallowing. Specialists in radio advertising have studied the psychology of the crowd and have learned to what things it responds favorably and to what it reacts unfavorably. They have studied the problem of pleasing the public as does an editor or showman.

The ability of the experts in these matters should be more generally recognized by the advertiser who pays the bill. Because one type of program may suit his individual taste is no guarantee that it will appeal to the general listener. Too much dictation as to the type of program or artists is not advisable if maximum results are desired.

The best advertising has been found to be that which holds the listeners' interest. Thus a sort of scenario with a musical setting, such as used in radio travelogues, often permits of unobtrusive advertising. A product or a service can frequently be dramatized so as to attract attention, induce interest, and even develop desire, which are the first aids to selling.

Experience has also shown that the effectiveness of radio advertising is enhanced by tying it in with other forms of advertising. Newspaper announcements of the time and place of a broadcast, window displays, billboards, souvenir booklets or novelties to be sent on request, all help to put the message across.

But notwithstanding the benefits to the advertiser and to the station thus supported, the success of the station depends upon the excellence of its service to the public. Just as a reputable magazine reserves the right to accept or reject what it proffered for publication, so the broadcast station must censor its entertainment, speeches and advertising. The good name of the station depends upon the care and thoroughness with which this is done.

Radio Censorship

Better Technique

Radio Advertising

Alaska Reaches Out

By Roy A. Anderson

KGBU is probably the farthest north broadcasting station of its type in the world. It operates on a regular schedule at Ketchikan, Alaska, the largest city of Uncle Sam's last frontier. The station is destined to serve a great part in upbuilding the southeastern section of the territory, for its power—500 watts—enables its reception hundreds of miles distant. Today there are hundreds of fox farms scattered on the islands of the archipelago, there are dozens of lumber camps, numberless mines and thousands of fishing vessels which, by necessity, are isolated from the towns and virtually have been without any means of communication with the outside world.

But the coming of KGBU heralds a new era. From now on the fox farmers will know what the outside world is

try. Witness the fact that during the sixty years the territory has been under the control of Uncle Sam more than \$600,000,000 has been set as the value of the salmon production. During 1925 more than 27,000,000 salmon were taken from Alaskan waters.

But aside from its value to the prosperity of the territory, KGBU marks an entertainment feature that cannot be overlooked. Handicapped largely by interference and distance, many who could not afford expensive radio sets have been forced to go without, but now in Ketchikan even the crystal will tune in Alaska's program. Operating daily except Thursday, the operators are endeavoring to put over the air a program comparable to those given the broadcast listener in the States. From 5:15 to 6:00 P. M. (Pacific Standard time)

and assured it not a little popularity—the Sourdoughs, an organization somewhat similar to the KGW Hoot Owls. Each week they frolic before the microphone for an hour or two of fun. From 11 to 12 A. M. Sundays church services are broadcast.

Since the station has been in operation check-ups have verified reception



Alaskan Fox Farm.



Radio Station KGBU, Ketchikan, Alaska

doing. They will know what is happening in the "fur world." And the lumber men will be able to learn what timber is doing so they can guide their actions accordingly; the miners will learn information vital to their well being and prosperity. While the fishermen will have almost at their finger-tips information as to fish prices and weather conditions.

The importance of this last phase cannot be over-emphasized. In the past fishermen have braved the open ocean in small vessels, coping with the elements as only the bravest can. The native ability to judge an approaching storm, supernatural as it may seem, cannot compare with the scientific observations of government meteorologists. To those boats which will be equipped with receiving sets—and no doubt the majority soon will be—KGBU will be able to give a wonderful service. And this service will be felt by all Alaska, for fishing today is by far the principal indus-

try. music, talks and news items furnished by the Ketchikan Chronicle are broadcast—except on Thursday and Sunday.

Then on Sunday at 10:30 P. M. comes the real feature which already has proved a boon to the station's success

in many of the eastern states, including New York, and letters have indicated a considerable number of regular listeners in Washington and Oregon.

For the first time in the history of the territory, radio broadcast played its part in the election of November 2, as KGBU broadcast returns furnished by the Chronicle in Ketchikan. The station had been in operation for only a short while then. The response was instantaneous and indicated that from the reception already given KGBU was bound to win a place for itself in Alaska.

Indeed, in Alaska, where transportation and communication are both slow and difficult, radio holds the cards that should win for it a hearty reception, for with its aid that vast territory can be builded on a firmer foundation with a speed commensurate with the country's needs.



A Section of Ketchikan's Water Front.

"A B C" Socket Power For Large Tubes

Directions for Assembling New Eliminator Parts To Supply All Power Requirements of Browning-Drake Set With Series Connected Filaments

By G. M. Best

WITH the recent development of factory built transformers, chokes, condenser banks, and resistors for use with the Raytheon 350 milliamperer tube as an ABC socket power device, it is unnecessary to use home-built parts, as described in June RADIO. The job becomes merely one of assembling the parts, quite a choice of which is now available.

Several such complete power plants have been assembled and tested in RADIO'S laboratory. Therefrom it is possible to give the necessary instructions for assembling different combinations, all of which have given excellent results with sets wired for series filament operation. Directions are also given for thus wiring a Browning-Drake receiver.

The essential apparatus required for the power plant includes a power transformer, 20 henry choke, a 16 mfd. condenser bank with four 1 mfd. by-pass condensers, and a set of output resistances. A typical circuit arrangement for these parts is shown in Fig. 1, which is a schematic diagram of the power plant shown in the picture, Fig. 2.

The transformer has a 110 volt primary and two secondaries, center tapped, one having a total of 700 volts for the plate circuit, giving 350 volts each side of the center; the other gives 5 volts, for lighting the filament of the 1/2 ampere type 371 power tube used in the last audio stage of the receiver. The rectifier tube is connected to the 350 volt secondaries as shown in Fig. 1, and

the output passes through the filter, giving an effective voltage of 220 d. c. at the filter output, when between 300 and 350 milliamperes are being drawn from the rectifier. This is essentially the same circuit as was shown in June RADIO, except that power transformers with a high leakage reactance are used. In case the tube flashes over at the start, when

voltage required for the particular receiving set with which it is to be used. In Fig. 1 a single resistor having a total of 4760 ohms, with a current carrying capacity of 350 milliamperes, is used; taps being taken out so that B voltages including 22, 45, 67, 90, 135 and 157 may be had, and C voltages from $-4\frac{1}{2}$ to -40 volts, for the power tube. C volt-



Fig. 2. Assembled Power Plant, for Combination No. 1.

the tube elements are cold, the transformer secondary voltage drops sufficiently so as not to burn out the tube. In the data for home construction of the power transformer, an 80 volt primary winding was used, the remaining 30 volts from the 110 volt power circuit being absorbed in a 22 ohm resistance placed in series with the transformer primary.

With 220 volts available at the filter output, the principal problem is to divide it into the different values of A, B, and C

ages for the other tubes in the receiver are obtained by the voltage drop across the filaments of the various tubes in the set, as will be explained later.

The A current for the receiver is 250 milliamperes, which flows through the resistor from the 180 volt terminal to the point marked A plus in Fig. 1. After passing through the filaments, it returns to the resistor at the A minus terminal, and flows through the remaining part of the resistor to the other end, at the $-40v$ C terminal. A 150 ohm variable

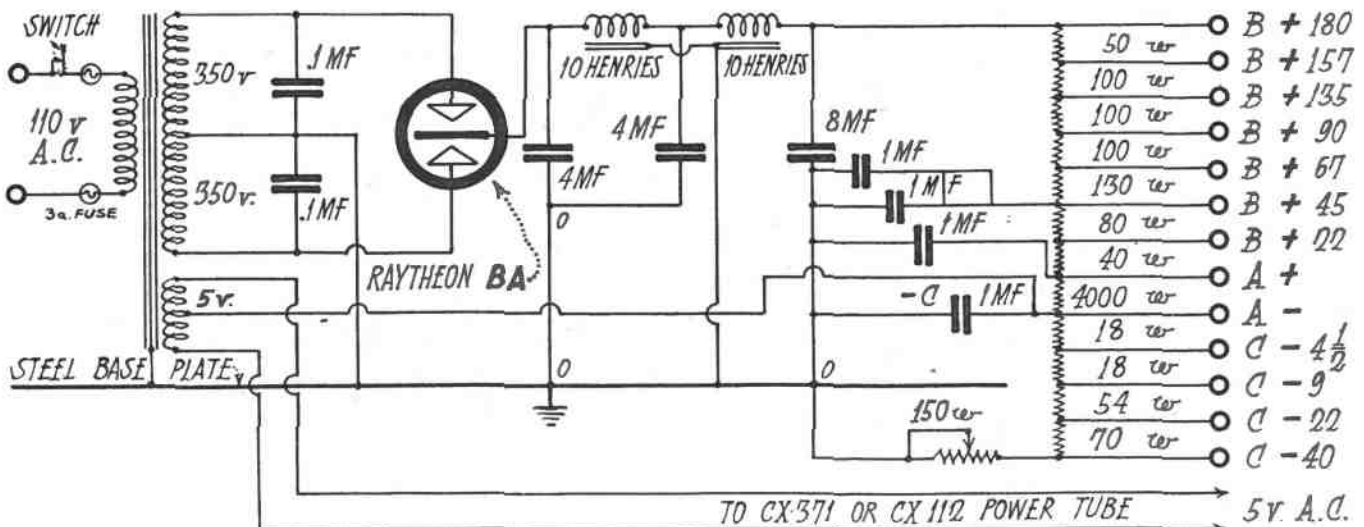

Fig. 1. Diagram of "ABC" Power Plant, Apparatus Shown in Combinations No. 1 and 2.

resistor is placed between the -40 C terminal and the minus terminal of the rectifier, to cut down on the A current, should it exceed 250 milliamperes. The 4000 ohm resistor draws practically no current when the filaments of the receiving set tubes are connected, but in case one of the tubes burns out, or is removed from the set while the rectifier is turned on, the total current through the resistor will not be less than 40 milliamperes, thus preventing a sudden surge of current through the tube filaments when a new tube is inserted in the receiver. If this 4000 ohm resistance is not used, and the filament circuit is suddenly closed while the rectifier is running, a surge of current will surely burn out one or more of the tubes.

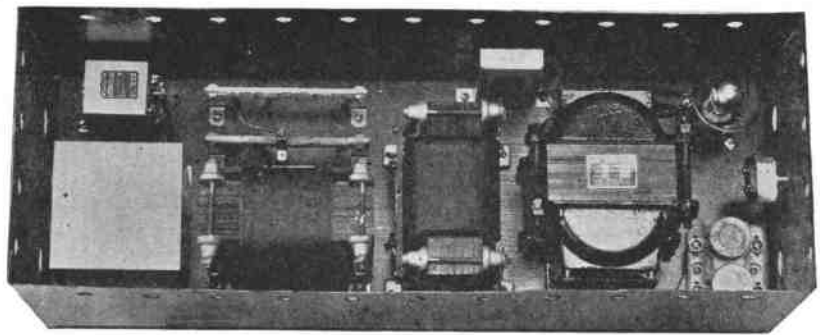

Fig. 5. Assembled Power Plant Using Combination No. 2.

usual variable high resistance, similar to the method ordinarily employed in standard B eliminators.

The power plant shown in Fig. 2 has been arranged in as compact a manner

proximate positions shown in the picture. The pictorial wiring diagram of Fig. 3 shows the actual connections to all terminals. A list of parts used in this eliminator is given in the column marked "Combination No. 1." Two other combinations are also available, and the assembled power plants using Combi-

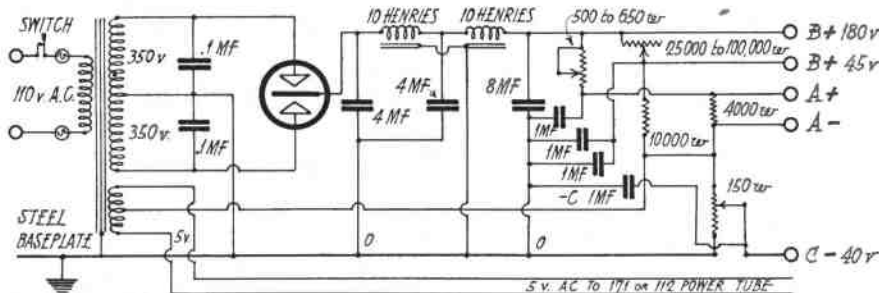

Fig. 4. Power Plant Circuit Arranged for Separate Resistance Control Using Apparatus Combination No. 3.

Fig. 4 shows a slightly different method of obtaining A , B and C voltages for the receiver, the changes being at the output of the filter. The filament current through the series filament circuit of the receiver is limited to 250 milliamperes by means of a resistance ranging between 500 and 650 ohms. This may be either a power rheostat capable of handling at least 50 watts of power, or a pair of 40 watt mazda lamps in series. The latter is used in one of the power plants shown in the pictures, and represents an economical and safe method of obtaining the proper resistance. The C voltage for the power tube is obtained from the voltage drop through a variable resistance of 150 ohms maximum, and B voltages below the maximum of 180 volts are obtained by the

as is possible, consistent with freedom from fire hazard. The apparatus is mounted on a metal baseplate $8\frac{1}{2} \times 22$ in., made by cutting No. 16 gauge sheet iron or steel to a size of $9 \times 22\frac{1}{2}$ in., and bending the edges to form a $\frac{1}{4}$ in. flange all the way around, so as to permit running the wiring underneath the plate. When completed, the power plant is placed in an iron or steel box of the same material as the baseplate, the box being $8\frac{3}{4}$ in. wide, $7\frac{1}{2}$ in. high and $22\frac{1}{4}$ in. long. Sheets of iron suitable for this purpose can be obtained from almost any hardware shop, or the boxes can be purchased ready made from the Western Transformer Co.

The assembly of the power plant consists in placing the transformer, chokes, condensers and resistances in the ap-

PARTS REQUIRED FOR POWER PLANT COMBINATION NO. 1

- 1 Dongan Type 3591 power transformer.
- 1 Dongan Type 3584 filter choke.
- 1 Tube ABC block—2 sections 4-4-8-1-1-1-1 mfd.
- 1 Tube buffer condenser block .1—.1 mfd.
- 1 X base tube socket.
- 1 G. E. Cat. No. 62965 porcelain fuse block.
- 1 Centralab 150 ohm power rheostat.
- 1 Ward-Leonard Type 507-62 resistor.
- 1 Cutler-Hammer push-pull switch.
- 1 Metal baseplate, $8\frac{1}{2} \times 22$ in. See text.
- 1 Metal can. See text.
- 1 Piece bakelite $3 \times 3 \times \frac{1}{4}$ in.
- 4 Brass rods, $\frac{1}{4} \times 4$ in., drilled and tapped at both ends.
- Miscellaneous screws and nuts.

tions 2 and 3 are shown in Fig. 5 and 6 respectively.

The baseplate is drilled with a No. 27 drill, the apparatus being held in place with $\frac{1}{8}$ and $\frac{1}{4}$ in. round head iron 6-32 machine screws, with lock nuts under the plate. A plug fuse block is placed alongside the transformer, and the 110 volt snap switch is mounted on the side of the metal box, the connections being made after the baseplate is lowered into the box. The plate is made the negative direct current wire for all the apparatus, and since it is grounded, it will insure the proper grounding of the metal cases of the condensers, transformer and choke.

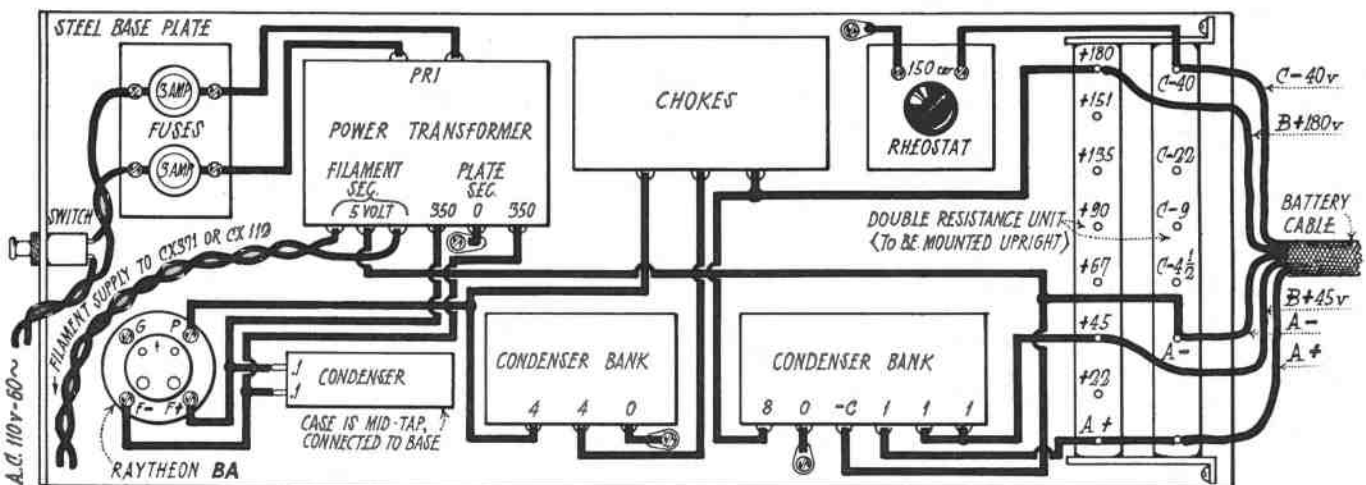

Fig. 3. Pictorial Wiring Diagram for Power Plant Combination No. 1.

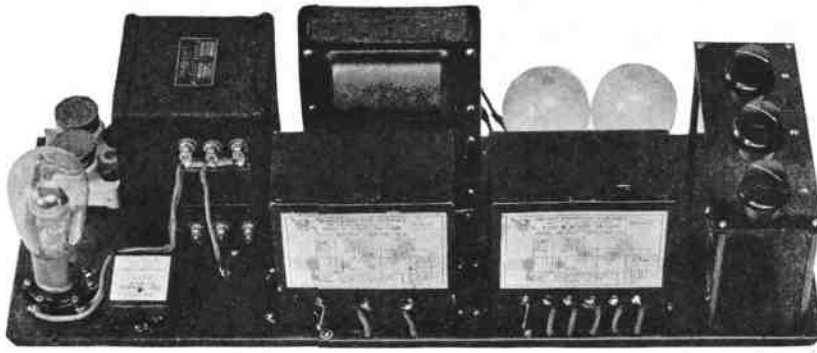

Fig. 6. Combination No. 3 of Power Plant Apparatus.

As much wiring as is possible is run underneath the baseplate, by drilling holes under the apparatus terminals on top of the plate, and using No. 14 or 16 rubber covered wire. Do not use spaghetti covered or bare wire in this installation, as it may chafe against the metal and short circuit the apparatus. A 5 wire battery cable is used to bring the minus and plus A, minus 40 volt C

PARTS REQUIRED FOR COMBINATION NO. 2

- 1 Acme power transformer for Raytheon BA tube.
- 1 Acme 20 henry choke.
- 1 Aerovox condenser block 4-4-8-1-1-1 mfd.
- 1 Aerovox buffer condenser block .1—.1 mfd.
- 1 Set Carter resistors for BA circuit.
- 1 X base tube socket.
- 1 G. E. Cat. No. 62965 porcelain fuse block.
- 1 4000 ohm fixed resistor-heavy duty type.
- 1 Cutler Hammer push-pull switch.
- 1 Metal baseplate 8½x22 in. with metal can. See text.

and positive 45 and 180 volt B connections to the receiver, and a separate piece of twisted lamp cord should be used to bring the 5 volt a. c. to the filament of the power tube. If the receiving set requires voltages other than 45 and 180 for B supply, additional wires should be included in the battery cable, from the B voltage taps on the resistor. Three ampere fuses should be used in the primary circuit, so that they will blow quickly if the tube becomes shorted internally due to flashover.

In Combination No. 1, the 150 ohm power rheostat used to obtain the power tube C voltage is mounted on a piece of ¼ in. bakelite 3x3 in., support-

ed by four brass pillars made by cutting up a piece of ¼ in. brass rod into four sections, each 4 in. long, drilling each end with a No. 33 drill and tapping for a 6-32 thread. Holes are drilled through the bakelite, for 6-32 round head machine screws, and the same should be done to the baseplate, passing the screws into the pillars from the under part of the plate. In Combination No. 3, there are two Clarostats for 45 and 90 volt supply, and a 150 ohm variable resistance, mounted on a ¼ in. bakelite panel 3x7 in., supported in the same manner as for the single rheostat. Underneath the latter panel is the 10,000 ohm fixed resistance, which should be of the heavy duty type.

PARTS REQUIRED FOR COMBINATION NO. 3

- 1 Thordarson power transformer for Raytheon BA tube.
- 1 Thordarson 20 henry choke.
- 1 Polymet condenser assembly 4-4-8-1-1-1 mfd.
- 1 Polymet buffer condenser group .1—.1 mfd.
- 2 Clarostats.
- 1 Centralab 150 ohm power rheostat.
- 1 Aerovox 10,000 ohm heavy duty resistor.
- 1 G. E. Cat. No. 62965 porcelain fuse block.
- 2 G. E. Cat. No. 50715 porcelain Mazda lamp sockets.
- 2 40 watt, 120 volt Mazda lamps.
- 1 Piece bakelite 3x7½ in. with 4 brass rods 4x¼ in.
- 1 Cutler Hammer push-pull switch.
- 1 4,000 ohm fixed resistor—heavy duty type.
- 1 Metal base plate 8½ x 22 in. with metal can. See text.
- 1 X base tube socket.

The Receiving Set

THE receiver used in testing the power plants was a standard Browning-Drake Kit Set, described by Glenn H. Browning in March

RADIO. This receiver was selected because it had radio frequency amplification, regeneration, resistance and impedance coupled audio, so that if the receiver worked perfectly with the power plants constructed, any other standard circuit will work equally well. A kit of the Browning-Drake parts, using only those recommended by Browning, was assembled, and such changes as were necessary for series filament operation were made. The revised circuit is shown in Fig. 7, and a pictorial wiring diagram showing the actual connections as they should be made is shown in Fig. 8.

As the Browning-Drake regenerative is designed to work out of a type 99 tube, it was thought best to use the 99 tube instead of compromising on a type A tube, as might seem easiest to do.

By reference to Fig. 7, it will be noted that the negative A circuit starts at the detector tube, which is a type A, then goes to the r. f. amplifier tube, which is a type 99, thence to the 1st audio where a type CX-340 high mu tube is used and finally to the 2nd audio, where a type A tube works best. The A circuit then passes through the two pilot lamps on the vernier dials, the lamps being connected in parallel, and thence to the positive A binding post. As the type 99 r. f. tube requires but 60 milliamperes, and the other tubes need 250 milliamperes, the 30 ohm resistance furnished with the Browning-Drake kit is placed in parallel with the tube filament, and the 30 ohm filament rheostat normally used for volume control when the tubes are in parallel, is also shunted across the filament, furnishing a perfect volume control as well as current bypass for the tube. Do not use a 200 or 400 ohm potentiometer at this point, or the volume control will be in the first ¼ in. of the resistance, and when set at maximum resistance, the current by-pass will be insufficient to protect the 99 tube.

The filament switch furnished with the kit is connected across the pilot lamps, to short them out when they are not wanted. It should not be placed in series, to disconnect the filament circuit altogether, as the power plant would still be running, and it is better to turn off

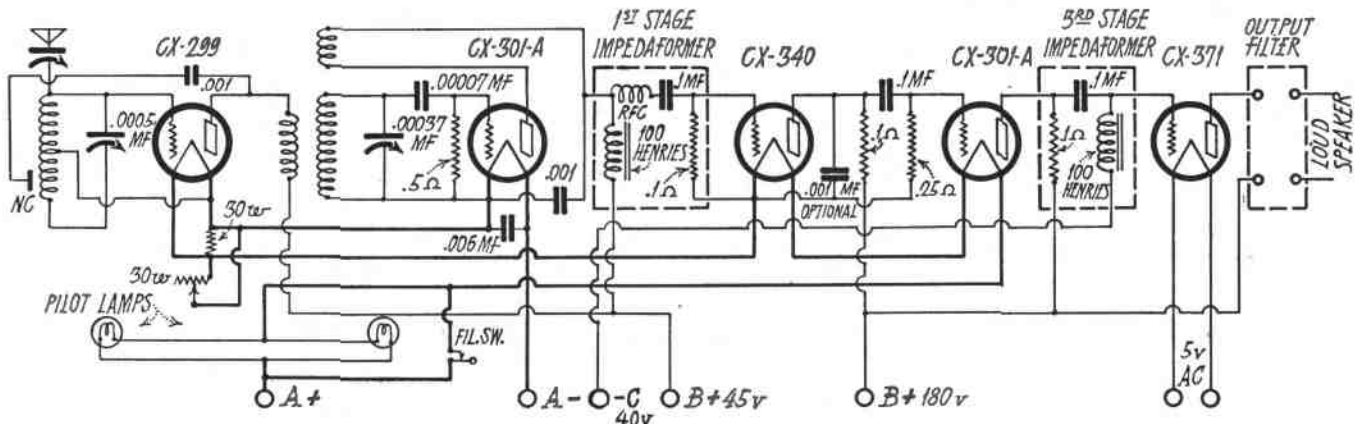

Fig. 7. Browning-Drake Circuit With Filaments Wired in Series.

Trouble Shooting The Single Control Set

Methods for Neutralizing and Balancing Tuned R. F. Receivers so as to Regain Sensitivity and Sharpen Tuning

By Max P. Gilliland

A SINGLE control tuned radio frequency set is a joy to operate until something goes wrong and then it becomes the meanest thing that can be imagined. Any service man will tell you this. It is hard to fix, especially where there has been a loss of selectivity. A great mystery surrounds it and everybody throws up their hands in despair and says "it can't be done."

At this point the set is usually returned to the service station of the local jobber for repairs. Some day you get it back, providing that the poor fellows there haven't about nine million others on hand with the same ailment. The reason is that everybody does the same thing. No one, this is said with certain reservations, for there are lots of very good service men, seems to understand the balancing of this type of receiver when it goes bad. With the proper equipment and a little patience it is very simple.

There are several sources from which a lack of selectivity may arise. The first of these is an unbalanced condition in the radio frequency stages. By this is meant that they are partially or wholly out of neutralization. This condition not only broadens the tuning but also kills the sensitivity of the receiver. The remedy is simple. If there are separate rheostats for the control of the radio tubes, so much the better.

The first step in the re-neutralization procedure is to tune in a very loud signal. Bring it in with all the volume you can. Having done this, turn out the filament of the first radio frequency tube. If there is no decrease in volume, that stage is entirely out of neutralization. When this occurs take a screw driver made from a bakelite rod 3-16 in. in diameter and adjust the little balancing condenser, which will be found near by, until the signal has entirely disappeared or has reached its weakest point.

In cases where tubes with the CX base are employed and there is no separate rheostat, the filament may be shorted out by carefully extracting one of the large filament prongs from the base of a good tube. A burned out filament will not suffice, as the slight change in the internal capacity caused by the incomplete filament wire will throw everything out of balance and defeat the whole purpose of the adjustment. Where an ordinary socket is used, a small

piece of paper may be placed over one of the filament prongs.

When you are satisfied that you have reduced the signal to its lowest possible intensity, then that particular stage is neutralized. If there is a trimmer across the main tuning condenser of this particular circuit, all of these adjustments must be made with the rotary plate half exposed. Always work from the antenna towards the detector.

The second and harder task is the balancing of the tuned circuits. Many technicians try to secure a satisfactory adjustment by using local broadcasts. This will never do under the present conditions. The only efficient means of obtaining a balance is by means of a modulated oscillator located near the set to be fixed. When properly constructed, this provides a very sharp sig-

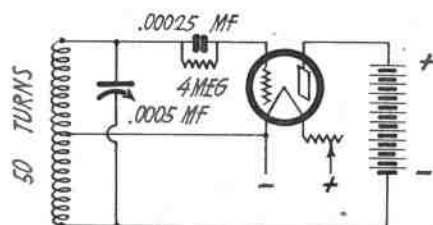

Circuit Diagram for Modulated Oscillator

nal. By placing it at some distance from the work bench and running a radio frequency feed line to the receiver, the best results will be obtained.

Lack of balance is usually denoted by one of the trimmers showing a resonance point at the extreme end of the scale, or else having no effect at all. If the former condition exists, loosen the coupling of the particular condenser to be adjusted and slip in whatever direction necessary. A definite position will be noted where the coupling should again be tightened. This should all be done with the rotary plate of the trimmer half out. In this way a lee way is provided on each side of the point of resonance, which will take care of any peculiarities in the tuning characteristics of the coil.

When the vernier has no effect and several of the stages seem to be out of tune, loop the r.f. feed line from the oscillator once around the inductance in the last radio stage, that is, the one feeding the detector. Tune in the signal with the regeneration control, if there is any, set at minimum. Mark the dial or else make a notation of the exact position in which the sound is the loudest.

With this done, loop the wire around the r.f. transformer in the stage preceding the detector. Again tune in the signal. At first it will be weak, but upon moving the condenser of this stage back and forth, a maximum intensity may be secured. The coupling of this unit should then be tightened. Be sure that the trimmer is turned half way out.

This process is then repeated for as many more stages as the set may have. The point of resonance for each stage should coincide with the first dial setting obtained. This means that when you turn the dial to the marking, the signal will be at greatest intensity and that the trimmers will both show a resonance peak at the same point on their scales. Using the oscillator this should fall at the middle.

If an attempt is made to use a broadcast it is quite common for the first stage trimmer to tune way off. This is because the wave emitted from the station is broad. Such procedure might work out very nicely on locals only, but when the operator tries to tune in distance, he is in just as bad shape as he was in the beginning, for the set has no sensitivity. A second check on neutralization must be made after the circuits have been balanced.

There are times when the service man has to do something to provide a smoother control of volume. Several methods are employed today. A common form is the placement of a rheostat in the filament lead of one of the r.f. tubes. This is rather noisy when a wire wound resistor is used. It also tends to produce an unstable condition in that stage as the variation in filament temperature will change the degree of neutralization. Carbon piles are out of the question, if you wish to set the thing and leave it.

Perhaps the most satisfactory volume control is a shunt resistance across the secondary of the first audio transformer. This in no way affects the filament current. It allows a greater ease of adjustment on weak signals. The action of a high resistance across this particular part of the circuit is absolutely noiseless. In this way the radio tubes are left working at full efficiency.

Another problem is to increase the grid and plate voltages on a Power Tube in the Last Audio Stage without disturbing the structure of the set. A

(Continued on page 48)

Recent Improvements in Resistance Coupling

By Arthur H. Lynch

THE difficulties in the path of resistance coupled audio frequency amplification have been overcome by the development of high mu tubes, power tubes, metalized filament resistors, high plate voltage supply, tone filters and loud speakers. So that now fidelity of tone reproduction is an accomplished fact and well nigh perfect audio frequency amplification is possible. The influence of each of these several factors is of interest and value to trace.

As there is no voltage step-up in the coupling units of a resistance coupled amplifier, in contrast to a transformer coupled amplifier, the use of tubes of the 201A type, in which the *mu* or amplification factor of the tube itself is rather low, results in insufficient volume. A tube with a high amplification factor overcomes this objection to resistance coupled amplification. First some of the independent tube companies, such as the CeCo, developed tubes with a *mu* of about 20, and finally Cunningham and the RCA placed a tube on the market with a *mu* of 30. In order to increase the *mu* of receiving tubes it is necessary to alter the relative spacing of three elements, the grid, plate, and filament. An incidental result of this change in element spacing is a marked increase in the plate impedance of the tube.

One of the requirements for distortionless amplification is that the effective primary impedance of the coupling unit at the lowest frequency to be fully amplified be higher than the plate impedance of the vacuum tube. In a resistance coupled amplifier this merely means the selection of the proper size plate resistor. In the case of a transformer coupled amplifier, however, it means increasing the inductance of the transformer primary until the desired impedance is secured, a process which limits the use of transformers in their present state of development to tubes with plate impedance not in excess of about 10,000 ohms.

As a result of the very high plate impedance of high mu tubes and the corresponding high resistance of the coupling resistors, the plate current drawn by a resistance coupled amplifier is exceedingly low, making for economical operation.

Low notes and high notes are all needed for quality amplification. Without high notes, the reception lacks character, the overtones and higher harmonics are lost, and many letters of the spoken alphabet sound alike. B, c, d, e, g, p, t, v, z, all sound the same without the higher frequencies that serve to

differentiate between them. Without low notes, mellowness and power are lost; the reception sounds tinny.

But low notes require considerable energy for their reproduction and a voltage amplifier can supply no appreciable amount of energy. Thus, for quality amplification, be it resistance or transformer coupled, the last stage must be a power stage.

A power stage using CX-371 or CeCo J-71 has a very low *mu*, giving but little voltage amplification, but supplying the energy necessary to actuate the loud speaker in accordance with the variations in the signal as built up by the voltage stages.

The plate impedance of a power tube is usually quite low—2,000 ohms in the case of a 71 type as against 150,000 ohms of a high mu tube—and as a result the plate current is rather heavy, making the use of a B power supply unit advisable when possible.

There is nothing upon which more depends for the proper operation of a resistance coupled amplifier than the resistors. They must, first of all, be capable of continuously carrying the currents passed through them without deterioration. Then they must remain permanent in value. And, finally, they must be absolutely silent in operation. Impregnated paper grid leak type resistors were tried for this purpose and found to be entirely unsuccessful from all three angles. Now, a new resistor, resembling the old only in size, has been developed. This is the metalized filament resistor, which consists of a fine glass core into which is baked a conducting high resistance film of metal. The result is a unit ideally suited for resistance coupled amplification.

Due to the high direct current resistance of the plate coupling resistors in a resistance coupled amplifier a high plate voltage is necessary for the high mu tubes. This voltage must be at least 135 and preferably 180 or even higher.

As the plate current drawn by the high mu tubes is exceedingly low, this voltage may economically be obtained from B batteries. The power stage, however, requires a high plate voltage also, at least 135 and preferably 180. The plate current consumed by the power tube, unlike the high mu tube, is quite high and as a result not as economically obtained from batteries. The real answer to the question of plate voltage is a lamp socket B supply which will furnish at least 180 volts and all the desired current, for all the tubes. Great strides have been made in the battery eliminator field and the better grades of B power units are now in every way reliable and serviceable.

In using many B power units with a resistance coupled amplifier it is necessary to either insert a phase shifting inductive reactance in the grid circuit of the power stage or else to use the special "non motor-boating" amplifier circuit described for the first time in this article. The novel feature of this amplifier circuit is the resistance-capacity filter in the common plate lead to the detector and first high mu tubes. This method was devised by R. M. Wise, chief engineer of E. T. Cunningham, Inc.

Unless such a choke is employed the "chug-chug" effect often referred to as "motor-boating" is likely to take place when using a B power unit with a resistance coupled amplifier. The ability of resistance coupled amplifier to respond to the lowest frequencies depends entirely upon the relative values of the coupling condensers and grid resistors.

Decreasing the capacity of the coupling condensers below .1 mfd. will cause the response curve of the amplifier to fall away at the lower notes unless the grid resistors are at the same time increased in value. Thus the .006 mfd. condensers and 2 megohm leaks specified in this article will result in essentially the same response curve as the 0.1

(Continued on page 72)

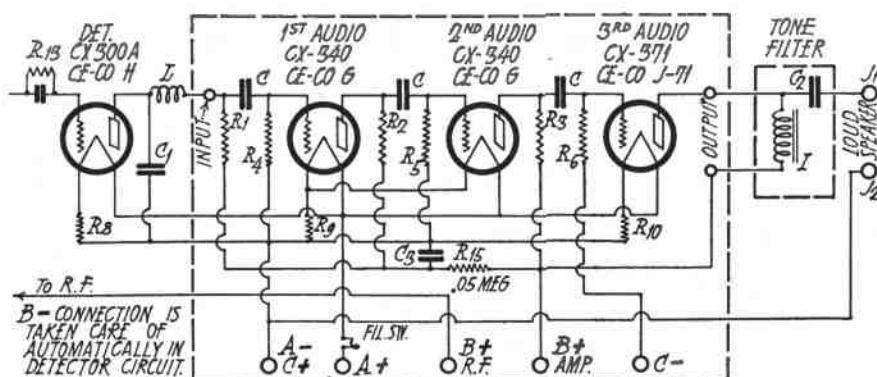

Fig. 1. Circuit Diagram of "Non-Motor-Boating" Amplifier.

Mahoney's Hunch

By Earle Ennis

BANJO ED was known to radio fame from East to West as the snappiest, most original artist with pigskin and voice that ever stepped before a microphone. Old ladies in a dozen states loved him like an only begotten son. Tired business men forgot their worries and awaited his appearance on a program with the keenest anticipation, and small children were allowed to "sit up late" when he appeared. And yet—there was something peculiar about Banjo Ed!

Just why the Bankers' Association gave him so much attention could be explained only by Jerry Mahoney, special operative of that great web of criminal catchers, for the suspicion originated in Jerry's head on a late September evening and he said nothing to anyone about it for a long time. And then, when he had watched and waited and studied until it was all clear he acted on that thing called a "hunch" and spaded up what proved to be one of the major sensations of the day.

In appearance Banjo Ed was a small, bandy-legged, undersized, half-portion "bindle stiff"—a hobo with pack on back and a ratty dog, as unkempt and unshaven as himself, at heel. Atop his pack he carried his precious banjo—a rusty, tuneful affair from which he evoked his intriguing harmonies. When he spoke, Banjo Ed had the nasal whine of the typical hobo, but when he sang, it was with a full rich tenor—an anomaly that often exists.

Banjo Ed had burst upon the radio world a year before when he panhandled his way from coast to coast by singing, free-lance, at most of the big broadcasting stations in the country. In his muddy boots, with his dog beside him, he stood before microphones where opera stars and bank presidents had trod before, and even the most meticulous program director was forced to admit that despite his appearance he was able to elect himself a prime favorite in a short half hour. For Banjo Ed was that rarity known as the "born entertainer" who held his audience by some subtle magnetism of his own.

This particular year Banjo Ed was playing the smaller towns where baby broadcast stations spanned a few hundred miles up and down state and served local communities. There, where directors were always hard put for talent, he was received with open arms and many a greenback found its way into his grimy hands at the end of a performance. Yet so thoroughly was Banjo Ed



what he was, that the next day would find him with the money strapped against his skin, begging a meal from some kindly farmer's wife. If, by any chance, there happened to be a radio set in the place, he always introduced himself and the ranch was his for the asking.

All this was known to Mahoney of the Bankers' Association, who had looked up the history and activities of this queer figure of the night air lanes, with a minuteness of detail that was unusual for him, as particular as he ordinarily was. He could not explain this care, even to himself, except that he told himself it was his "hunch" working again. As always, he decided to play his hunch to the limit.

Trailing Banjo Ed from place to place, through the reports of association operatives, a suspicion that had been slowly forming in the back of his head, began to crystallize. He finally laid it all down to his chief, Sam Barry, an ex-chief of police and one of the best men in the business.

"All I've got is this funny hunch and a few dates," he explained through the smoke of a black cigar. "But, at that, I'm sure I'm dead right."

Barry listened with intense interest. He had seen some of Mahoney's hunches before.

"Let's see what you've got," he said. Mahoney laid out a package of slips

on which he had pencilled certain dates and memoranda. He explained.

"The Bankers' Trust Company at Spurlock was nicked on the 27th. Banjo Ed broadcast from WSAW on the night of the 26th. The Citizens' National was rapped at Elk Hill on the 29th. Banjo Ed was at WPAG, the Elk Hill power company's station on the 28th. Then there is the Kenny National; that was tapped on the 4th of this month. Banjo Ed did his act from KWKO in Kenny on the 4th." He tapped the cards significantly.

"Hum," said Sam Barry. "In each case Banjo Ed was in the town the night before the Dallas gang cleaned up. Interesting if nothing more."

"Well, there's a lot more," said Mahoney grimly. "I've gone back to the Green River payroll stickup. Do you remember where they used machine guns in Eagle Pass and nicked the Green River mine people for \$85,000. Banjo Ed was in Miney, eight miles away, on the 3rd of that month. The payroll job was on the 4th. Now—ain't that a sweet mess of patooties?"

Sam Barry whistled softly.

"You've got a hot trail as sure as a snake has a belly," he said. Mahoney leaned forward.

"The way I have it doped out," he said. "Banjo Ed is a line-up man for the Dallas gang. He goes into a town, gets all the data for 'em, and then

shoots it to them. They follow him in and make a cleanup."

"Did you check the telegraph offices?" asked Sam Barry.

"Telegraph, telephone and mail—nothing doing. No—I think he slips the data over the air while he is doing his song and dance stuff, or whatever it is he does. The gang have nicked twenty-two banks and five payrolls and in each instance Banjo Ed was on the microphone just one night ahead of them. Laugh that one off!"

Sam Barry's lips tightened.

"How does the banjo weazel put it over?" he asked, after a bit. "Coded music?"

"Don't think so," Mahoney replied. "I thought of that myself—you know, such and such a song meaning such and such. But it appears not. In at least three stations, he let the program directors pick the pieces. He can sing pretty nearly anything, and if he was using coded songs it would scramble his stuff to let somebody else do the picking. No—he's got an entirely new stunt—one that has never been worked before. I am trying to figure out what it is!"

"Look here," said Sam Barry. "If we know where this bird is going to be—to broadcast, all we have to do is to lay a trap at the bank in that town and we've got the gang."

Mahoney laughed.

"Nothing so easy as that," he said. "He skips. Sometimes he plays in a town and nothing happens. Then again he plays and nothing happens for a week. The cases I have cited, the robberies occurred on his heels, but not always. You might shadow him for days and get nowhere. No—Jake Dallas and his crowd are not going to leave an open trail that way. The one thing I am certain of is that Banjo Ed is always somewhere near the stickups when they occur. That's why I tie him in with them."

Sam Barry sucked at his cigar reflectively.

"What's your plan?" he asked, after a bit.

"I'm going to do a disappearing stunt," said Mahoney. "Drop right out of sight. When I come up for air it may be anywhere. But don't start paging me unless I yell for it."

Barry grinned.

"Well, you shoot me a wire once in a while," he said. "You're up against a bunch of bad eggs in that Dallas gang."

They talked for a while longer, Mahoney outlining some of the details of his scheme before they parted. Two hours later, the Association sleuth walked into a garage where he kept his battered flivver.

"Load her up, Joe," he said, to the garage attendant. "I've got a long trip ahead and I want plenty."

He had. Late that night he struck out for Los Puentos, nearly a thousand miles to the southwest where one of his reports said that Banjo Ed had last been "on the air" with his peculiar act. He had to pit a lone hand against the cleverest gang of bandits then operating in the country.

PINKTON was a town of about ten thousand persons. It had two banks—the Citizens' Trust and the First National, a chamber of commerce and a 500-watt broadcasting station. Wherefore Pinkton held up its head proudly among sister municipalities of its state and doffed no chapeau to any community more progressive.

Up state journals liked to poke fun at Pinkton in a quiet way because of its metropolitanism, its snappy police department, its new fire engine, and its boosters' clubs. But one thing they did not deride, and that was its bank clearings, for Pinkton garnered the wealth of two valleys and its annual record was something to conjure with.

Thus it happened that Jake Dallas, sitting in the Union hotel at Martinsville, sixty miles away, with his feet cocked on a billiard table, read with interest the monthly report of the financial condition of the First National bank at Pinkton as recorded in a front-page box of the Martinsville Eagle. Jake was the deus ex machina behind the Dallas gang, despite his trunk of shoe samples and his breezy manner with waitresses and cigar girls.

Further examination of the newspaper by Jake revealed half a column devoted to Pinkton activities, from which Jake gathered quite a bit of information of the kind he needed in his business. For a long time he sat with a faraway look in his eyes. Then abruptly he arose, stretched and hied him forth to the local telegraph office where he sent a wire to "Banjo Ed, Owens, Cowan county"—a wire which one salesman might send to another.

This done he dropped into an electrical store, purchased a new set of batteries for his portable loop receiver which he carried with him on the back seat of his fast little roadster, laid in a supply of cigarettes and returned to the hotel.

It was late that same afternoon that Banjo Ed dropped into the Western Union office at Owens and asked if there were any wires for him. He needed no identification to the operator on duty. His dusty pack and rusty banjo were identification enough, and the operator grinned as he passed a telegram across the counter.

"You're on the air here tonight, ain't you?" he asked.

"Yeah," said Ed in a bored tone. "And tomorrow—God knows where.

They jump me around so, there's no tellin' where next."

He ripped open the envelop and studied the message from Jake Dallas. Then he flipped it around for the operator to see.

"What did I tell you?" he growled.

"Yeah—I was just thinkin' of that when you spoke," said the operator who already knew the contents. The message read:

"Play in Norristown Keller to open north."

There was no signature. The operator read it as written—and accepted it as Banjo Ed interpreted it. But Banjo Ed read it differently. He discarded the words and kept only the first letter of each. The result spelled "Pinkton." To the operator, the message meant another "jump" for Banjo Ed. To Ed the message meant another stickup at Pinkton, twenty miles away.

"I'll be listening for you," said the operator as Banjo Ed gathered up his pack.

"I'll be there," said Ed and shuffled out to find a cafe where the steaks were thick, and the onions plentiful and the coffee had a kick to it. As he shambled through the doorway of Al's Owl cafe, a dirty, battered lizzie drove up and died with a rusty cough. Jerry Mahoney, tired and stiff, climbed out of its dusty depths. The lowering sun gleamed for an instant on the metal work of a banjo strapped atop the pack of a bindle-stiff as he passed through the cafe door. Mahoney's face lighted. The Bankers' Association had picked up the trail of the Dallas gang at last!

Contrary to popular impression a detective does not always shadow a man he seeks by following him. Frequently he keeps entirely away from him. But there are ways and means of knowing what he is doing. In the case of Banjo Ed, Mahoney knew he was due to broadcast at the Owen station that night so he wasted no time in following him about the town. Instead he registered at a local hotel, bought a handful of cigars, ate a good dinner, and dropped in at the telegraph office.

Mahoney went heeled with a number of things. One was a set of credentials, all genuine, which would identify him to any telegraph operator as a special agent of the company. This gave him the entre to information which he could not obtain in any other way. It also, frequently, had the effect of automatically deputizing the operator as his assistant—a most valuable aid.

Presenting his credentials, Mahoney explained what he wanted.

"I am trying to trace a James Hanscomb," he said. "He got into us for several hundred dollars in Ohio . . . supposed to have a sister living here some-

(Continued on page 74)

The R. M. A. Show at Chicago

THE 1927-1928 radio season was officially opened coincidentally with the opening of the Radio Manufacturers' Association show in Chicago on June 13th. While this was exclusively a trade showing of advance models, many of which will not be on general sale for several months, it is nevertheless of intense interest to the user of radio equipment. Consequently an attempt is here made to interpret the probable trend of radio during the next year so that the readers of RADIO may know what is new in the art.

The most noticeable fact was that there are no radical departures from present practice. There were no revolutionary circuits or marked changes in design. Standardization and simplicity were the keynotes.

The newest thing was the a. c. filament tube upon which engineers have been working for years. But with the practically simultaneous perfection of the socket power devices for supplying rectified and filtered alternating current to the filaments of d. c. tubes it is yet impossible to predict which method will meet with the greatest popular favor. Nor is the battery likely to be immediately displaced by either.

Greater simplicity in control was the dominant feature of the factory-built sets. In many of them the complete control of the entire set is concentrated in the center of the panel. Some are so similar in appearance that it is necessary to read the name plate to distinguish them in outward appearance. Most of the new sets have illuminated dials with drum control. In fact the large circular dials that used to be plastered on the front panel seem to have been thrown into the discard.

The same standardization applies to the interior arrangement, most of which is concealed from casual view by shielding. Six tube sets with three stages of tuned r. f. and two of a. f. amplification are standard for average broadcast reception. The black polished panel of the past is almost universally replaced by metal panels or by wooden panels backed with metal for rigidity. Where bakelite panels are used they are grained and finished to represent mahogany or walnut. The metal chassis is also in general use.

Along with the improvement in selectivity and tone quality that characterizes the new models is a corresponding improvement in appearance. Even the small table cabinets are more beautiful. The consoles and highboys represent not only the finest examples of the cabinet makers art but also in many cases are the result of the artistry of noted designers. The radio set of today can be made to harmonize with the furnish-

ing of any room.

The same trends were observable in the exhibits of the kit and parts manufacturers. In fact there is no desirable feature of a factory-built set which cannot be duplicated by those who prefer to roll their own. Whether in the simplicity of drum-dial control of ganged tuning condensers, new panels, shielding, or in finished appearance, the home-built set compares most favorably with the factory output.

"The leading broadcast stations are transmitting music of irreproachable tonal excellence. The ordinary cheap or old-fashioned radio set does not begin to do justice to the music in the air. When such music is filtered through a cheap, poorly designed receiver, its phonograph-like sound offends. Yet, right nearby, a good receiver may be taking the very same ether impulses and converting them into gorgeous tone harmonies.

"The average home is receiving not the 1927 radio that is in the air, but rather 1923 radio, or 1925 radio,—depending on the date of the set being used. The public fails to realize this, and we radio people haven't yet impressed sufficiently upon them how much they are missing.

"Surprising progress has been made in achieving tone quality in receivers during the past year or two, and the family which can afford to invest several hundred dollars in a modern radio receiver, and has not done so, is simply depriving itself of values that would cost many times more, measured in terms of concert tickets, phonograph records, or any other form of entertainment." — Radio Commissioner O. H. Caldwell.

Of the various accessories, the socket power devices and the loud speakers were the most in evidence. Almost all of the large radio manufacturers are making plate and grid voltage supply outfits and many of them are making filament current supply sets for both parallel and series connected operation. Yes the A battery eliminator is here, as a study of the following pages will show.

In the loud speaker field, the cone and drum types continue to hold the leading position. All have greater possible volume without distortion and a

wider audio frequency range than was common in last year's models. This is due not only to new units but also to improved tone chambers. Several manufacturers have developed a double tone chamber, one section emphasizing the low notes and the other the high notes.

Details regarding all of the exhibits are summarized hereafter, together with pictures and complete descriptions of much of individual material.

Good News for the Radio Builder

OUR most outstanding deduction, based upon personal study of the show exhibits, is the enlarged field for the home constructor of radio sets. Centralization of control and of patents is slowly but surely limiting the number of factories so that it is freely predicted that there will be less than a score of radio factories within three years. The expense of patent royalties will necessarily be included in the selling price of the factory built models. So that the individual radio builder will have the dual incentive of displaying the excellence of his own handiwork and of getting the best results in his own receiver at a minimum of expense.

This new condition of greater activity in the home construction of receivers has already been recognized by the manufacturers of radio parts, many of whom anticipate a greater market in the sale of parts to individuals than they have heretofore had in selling to the factories. Furthermore the new parts are so much better, electrically and mechanically, than those available in the past, that they can be easily assembled in an efficient set whose performance will equal if not surpass that of the factory-built model.

Some of the new kits, for example, have metal panel and chassis, drum dial control, gang condensers, illuminated dials, and complete shielding. Supporting brackets are now made so as to be adjustable as to height and length for use in building any size of set. The new variable condensers are more ruggedly constructed and have higher electrical efficiency. The r. f. transformers have closely confined fields. The new a. f. transformers give more nearly equal amplification of all musical notes.

At least a dozen new kits have been or shortly will be announced. These include Superheterodyne and Infradyne as well as less elaborate sets. The factories are striving to devise kits of parts that can be easily assembled in a few hours with a minimum of tool equipment. These will enable more compact and rugged construction than was previously possible. Most of the wiring goes below the sub-panel.

(Continued on page 90)

Specifications of Factory Built Receivers

Exhibited at R. M. A. Show

Maker	Name of Set	No. of Tubes	Price	Type or Style	Power	Circuit
Murdock	Murdock	7	\$60.00	Model 60 Table Cab.	Batteries or Power Unit.	T. R. F.
"	"	7	70.00	Table 70	"	"
"	"	7	125.00	Console 125	"	"
"	"	7	140.00	Console 140	"	"
"	"	7	155.00	Console 155	"	"
"	"	7	175.00	Console 175	"	"
Murad Laboratories, Inc.	Murad	6	92.00	Chassis	Batteries or Power Unit	T. R. F.
"	"	6	98.00	Table	"	"
"	"	6	172.00	Semi-Con.	"	"
"	"	6	265.00	Semi-Con.	Electrically Operated	"
Pfanstiehl Radio Co.	Pfanstiehl	5	\$64.50	28	Battery or Power Unit.	T. R. F.
"	"	6	99.50	30	"	"
"	"	6	179.00	Console 302	"	"
"	"	7	139.00	Table 32	"	"
"	"	7	237.00	Console 322	"	"
Indiana Electric Mfg. Co.	Case	9	\$350.00	90C Con.	Battery	Tech-nidyne
"	"	9	475.00	92C Con.	Wired for AC tubes	Tech-nidyne
"	"	9	485.00	92CX (25 cycle) Elec.	Wired for AC tubes	Tech-nidyne
"	"	9	225.00	Table Cab. 90A w/loop	Battery	Tech-nidyne
"	"	9	350.00	92A	110 V. 60 cy. Wired for AC tubes	Tech-nidyne
"	"	9	360.00	92AX	60 cy. wired for AC tubes	Tech-nidyne
"	"	9	375.00	92AX	25 cy. wired for AC tubes	Tech-nidyne
"	"	6	85.00	61A	Battery	Tech-nidyne
"	"	6	135.00	61C Hi'boy	Battery	Tech-nidyne
"	"	6	185.00	Table 62B	AC tube op. 60 cycles	Tech-nidyne
"	"	6	190.00	Table 62BX	25 cycle AC tube opr.	Tech-nidyne
"	"	6	235.00	Hi'boy 62C	AC tube op. 60 cycles	Tech-nidyne
"	"	6	240.00	Highboy 62CX	25 cy. wired for AC tubes	Tech-nidyne
"	"	6	65.00	60A Table Cabinet	Battery operation	Tech-nidyne
The Sparks Withington Co.	Spartan	6	\$65.00	615 Table	Bat. Opr.	T. R. F.
"	"	6	88.00	626 Table	"	"
"	"	6	188.00	615 AC El. Table Mod.	AC Op.	"
"	"	6	215.00	AC-6 Cab.	AC Op.	"
"	"	7	375.00	AC-7 Con.	AC Op.	"
"	"			Blt. in Spk. Console	"	"
"	"			Table Spkr. Table Type	"	"
"	"			"R" without Spkr.	"	"
"	"			"S" with Cone Spkr.	"	"
All American Radio Corp.	American	5	\$70.00	Model 44	operated or Battery	T. R. F.
"	"	5	125.00	Hi'boy 55	"	"
"	"	5	200.00	Console 66	"	"
"	"	6	90.00	Table 77	AC Op.	"
"	"	6	150.00	Hi'boy 88	"	"
"	"	6	225.00	Console 99	"	"
"	"	6	115.00	Table "Duet"	Socket Pwr.	"
"	"	6	175.00	Highboy "Sextet"	"	"
"	"	7	210.00	Blt. in Spk. "Forte"	AC Tubes	"
"	"	7	300.00	"Lorraine"	"	"
"	"	7	400.00	"Sovereign"	"	"
King Mfg. Corp.	King	6	\$70.00	Table 80	Battery	T. R. F.
"	"	6	140.00	Con. 80H	"	"
"	"	6 Sld.	115.00	Table 81	"	"
"	"	6 Sld.	210.00	Con. 81H	"	"
"	"	6 Sld.	220.00	Table 71	"	"
"	"	7 Sld.	375.00	Console	AC Socket Power	"
Crosley Radio Corp.	Crosley Bandbox	6	\$65.00	"Bandbox" Table Mod.	Wired for New AC Tubes. UY 227 w/ Pwr. Balanced Tube	T. R. F.
"	Crosley Cabinet	None	35.00	Console Model 400	Cabinet only to house above	"
"	"	None	65.00	Model 405 Cabinet	"	"
"	"	None	85.00	Model 410 Cabinet de Luxe	"	"
Note—The new BANDBOX Receiver Fits into these Cabinets.						
Precision Products Co.	Arborphone	6	\$65.00 to 600.00	Table and Console	Battery or Socket Power	OWN
Argus Radio Corp.	Argus Electric Radio	6	\$195.00	195-B Table Mod.	Completely Electrically Operated	R. F.
Valley Electric Co.	Valley	7	\$95.00	Model 71	Battery	R. F.
"	Valleytone	5	85.00	Model 52	"	"
Mohawk Corp. of Ill.	Mohawk I-Dial	6	\$65.00	Navajo Table Mod.	Every model available and equipped w/ Kellogg AC tubes at \$100 extra, incl. "B" eliminator	T. R. F.
Interchangeable Drawer Unit \$65.00 to fit all cabinet models without tubes.						
Freshman Equaphase		6	\$70.00	Model F1		
"		6	175.00	" G2		
"		6	110.00	" F2	Each of these models with loud Speaker and Cabinet.	T. R. F.
"		6	200.00	" G3		
"		6	135.00	" F3		
"		6	225.00	" G4		
"		6	160.00	" F4		
"		6	250.00	" G5		
"		6	185.00	" F5		
Chas. Freshman Co., Inc.		6	200.00	" G3		
"		6	135.00	" F3		
"		6	225.00	" G4		
"		6	160.00	" F4		
"		6	250.00	" G5		
"		6	185.00	" F5		
Stromberg Carlson Telephone Mfg. Co.	Stromberg Carlson	7	\$1240.00	Combined Phonograph and Radio Set	AC Op. entirely	T. R. F.
A. H. Grebe & Co., Inc.	Syncrophase	5	\$95.00	Syncrophase "5"	Battery or Socket Power	Syncrophase R. F.
"	"	7	135.00	Syncrophase "7"	Battery or Socket Pwr.	"
The Bosworth Electric Mfg. Co.	Bosworth Electric Radio	5	\$175.00	Table Mod.	Uses new AC tubes and wired for AC Opr.	R. F.
Colin B. Kennedy, Inc.	Kennedy "Royal Seven"	7	\$90.00 to 220.00	Table and Console	Battery or Socket Power	R. F. Inductively Tuned
Sleeper Radio & Mfg. Corp.	Sleeper Electric Radio	5	\$160.00	"The Scout" Table Mod.	Full electric operation	R. F.
"	"	5	175.00	The Console	"	"
"	"	5	235.00	Scout Con.	"	"
"	"	5	350.00	Electric Monotrol	"	"
Standard Radio Corp.	Standardyne	6	\$39.50 to 150.00	Table and Console	Adaptable for electric power unit	R. F.
Atwater Kent Mfg. Co.	Atwater Kent	6	\$90.00	Model 33	Battery or Socket Pwr.	R. F.
"	"	7	150.00	" 50	"	"
USL Radio Inc.	USL	6	\$69.50	DC-6 Table Mod.	Battery or Socket Power	T. R. F.
American Bosch Magneto Corp.	Bosch Radio	6	\$99.50 to 175.00	Table Model 66	Battery or Socket Pwr.	R. F. L.
"	"	7		Cabinet Model 76 with Spkr. built in	"	"
"	"	7	340.00	Cabinet with loop and Spkr.	"	"

All prices are Eastern prices. 10% usually added on all sets west of Rockies.

Specifications of Factory - Built Receivers Exhibited at R.M.A. Show

Continued

Maker	Name of Set	No. of Tubes	Price	Type or Style	Power	Circuit	Maker	Name of Set	No. of Tubes	Price	Type or Style	Power	Circuit
Freed-Eisemann Radio Corp.	Freed-Eisemann	6	\$125.00	NR-66 Table Mod.	Battery or Socket Pwr.	Neutrodyne	Stewart Warner	Matched Unit Radio	5	\$50.00	Model 300	Battery or Socket Pwr.	T. R. F.
"	"	7	175.00	NR-77 with loop Model	"	Neutrodyne & T. R. F.	"	"	6	80.00	" 525.	"	"
"	"	6	225.00	Electric Model 11	Wired for Elec. Opr.	"	"	"	6	125.00	" 705.	"	"
"	"	8	395.00	800-C with loop, cabinet & spkr.	Battery or Socket Power	"	Kellogg Switchboard & Supply Co.	Kellogg	6	\$215.00	Model 507	Battery or Socket Pwr.	R. F. L.
"	"	6	90.00	NR-8	"	"	Neutrowound Radio Co.	Neutrowound Allelectric	7	\$360.00	"Master Allelectric"	All Electric	T. R. F.
"	"	6	100.00	NR-9	"	"	Splitdorf Radio Corp.	Splitdorf	6	\$170.00	The Maestro	Battery or Socket Power	R. C. A. T. R. F. Lio. Group
The Amrad Corporation	Amrad Royal Series	6, 7 and 8		Table and Console	Battery or Socket Pwr.	Neutrodyne	"	"	6	133.50	The Intermezzo	"	"
Federal Brandes, Inc.	Kolster	6	\$265.00	Console with "B" Speaker	Built in "B" Supply	R. F.	"	"	6	75.00	RV 695	"	"
The Workrite Mfg. Co.	Workrite	8	\$160.00	Table Mod.	Battery or Socket Pwr.	R. F.	"	"	5	80.00	RV 80	"	"
J. B. Ferguson, Inc.	Ferguson	7	\$95.00	"Homer" Table Set.	Battery	R. F.	"	"	5	127.50	The Virtuoso	"	"
"	"	6	195.00	Model 18 Electric	McCullough & Raytheon Tubes, complete Elec. AC Tubes AC Opr.	"	"	"	6	112.50	The Concerto	"	"
McMillan Radio Corp.	McMillan Electric	6	\$170.00 to 325.00	Consoles	AC Opr. throughout	R. F.	"	"	6	275.00	The Warwick	"	"
Chicago Nipple Mfg. Co.	Rochester	8	\$335.00	9-A Desk with Temple Speaker and loop	Wired either for AC or DC Tubes Light Socket Operation	R. F.	Reichmann Co.	Thorola 2-Dial	5	\$65.00	No. 65	Battery	R. F. L.
"	"	8	275.00	8-A Table Model with loop	AC Tubes	"	"	Thorola 1-Dial	7	125.00	No. 66	"	"
"	"	6	235.00	6-A complete except Speaker	AC Tubes AC Opr.	"	"	"	7	90.00	No. 60	"	"
Kellogg Switchboard & Supply Co.	Kellogg "AC"	7 (Kellogg) AC Tubes		Consoles	Complete AC Opr.	R. F. L.	"	"	7	160.00	Highboy	"	"
The Cleartone Radio Co.	Cleartone	6	\$145.00 to 345.00	Table and Consoles	McCullough Tubes and Complete Socket Pwr.	R. F.	"	"	7	80.00	Chassis	"	"
Bremer Tully Mfg. Co.	Counter-phase	6	\$110.00	Table	Battery or Socket Power	Counter-phase	"	"	6	70.00	"	"	"
"	"	8	215.00	"	Electric Operated	"	"	"	6	80.00	Model for Private Label	"	"
"	"	8	350.00	Console	Battery or Socket Power	"	"	Thorola	7	90.00	Model 60 Table Set.	Battery or Socket Pwr.	"
Buckwalter Radio Corp.	Burad	6	\$75.00	Table	AC	"	Sonora Phonograph Co.	Sonora	7	\$395.00	Model 277	Battery or Socket Pwr.	R. F. L.
"	Epochanter	8	150.00	Table	McCullough Tubes and Complete Socket Pwr.	R. F.	"	"	7	250.00	Console	"	"
"	Muse	8	360.00	Console	AC Opr.	"	Audiola Radio Co.	Audiola	6	\$75.00	Table	Battery or Socket Pwr.	T. R. F.
"	Grandee	8	425.00	Console	AC Tubes AC Opr.	"	"	"	8	125.00	Console	"	"
"	Comrade	10		Console	AC Opr.	"	"	"	8	175.00	"	"	"
Steinitz Laboratories	Steinitz	6	\$100.00	Table	Electric wired for AC Opr. (199 Tubes)	R. F.	"	"	6	225.00	Baby Grand Style	"	"
"	"	6	125.00	"	"	"	Electric Research Labs.	Eria 2-Dial	5	\$59.50	C-12 Table	Battery or Socket Pwr.	R. F. L.
"	"	6	150.00	Console & Speaker	AC opr. (201A Tubes)	"	"	"	5	109.50	C-50 Con.	"	"
"	"	6	175.00	"	Battery	"	"	"	5	118.50	C-22 Con.	"	"
"	"	6	50.00	Table	"	"	"	"	6	89.50	C-13 Table	"	"
"	"	6	95.00	Console & Speaker	"	"	"	"	6	129.50	C-51 Con.	"	"
Paragon Electric Corp.	Paragon	6	\$375.00 to 400.00	"Lincoln" to "Monroe" Consoles	Completely AC equip'd & operated with Q.R.S. system	R. F. (Dble. Impd. Amp.)	"	"	6	85.00	C-53 Table	"	"
Diamond-T Radio Mfgs.	Diamond-T	6	\$110.00	Baby Grand Console	AC operated uses AC Sovereign Tubes	R. F.	"	"	6	165.00	C-52 Con.	"	"
"	"	7	250.00	"The Chief" Console	"	"	"	"	7	165.00	C-60 Table	"	"
"	"	6	75.00	"Diamond Special" Table Set.	"	"	"	"	7	245.00	C-61 Con.	"	"
"	"	7	65.00	"Super Special" Table Set.	"	"	"	"	7	285.00	C-62 Con.	"	"
"	South Bend	6	135.00	Table Set.	Completely AC operated Sovereign Tubes	"	F. A. D. Andrea, Inc.	Fada	8	\$400.00	SF-50-80 Console	Battery or Socket Pwr.	Haseltine Latour R. C. A.
"	"	6	175.00	"	"	"	"	"	8	300.00	480-B Table	"	"
"	"	6	50.00	"	"	"	"	"	7	285.00	SF-45-77 Console w/ Speaker	"	"
"	"	6	95.00	"	"	"	"	"	7	185.00	475-A Table with Loop	"	"
"	"	6	375.00	"	"	"	"	"	6	160.00	460-A Table Type with Loop	"	"
"	"	6	400.00	"	"	"	"	"	6	225.00	SF-10-60 Davenport Table	"	"
"	"	6	110.00	"	"	"	"	"	6	250.00	SF 20/60 Beethoven Grand	"	"
"	"	7	250.00	"	"	"	"	"	6	300.00	SF 30/60 Queen Ann Desk	"	"
"	"	6	75.00	"	"	"	"	"	6	275.00	SF 40/60 Console	"	"
"	"	7	65.00	"	"	"	"	"	6	95.00	265-A	"	"
"	"	6	135.00	"	"	"	"	"	6	85.00	192-A Neutrolette	"	"
"	"	6	175.00	"	"	"	"	"	5	125.00	175-A	"	"
"	"	6	175.00	"	"	"	"	"	5	175.00	185-A	"	"

All prices are Eastern prices. 10% usually added on all sets west of Rockies.

Socket Power Devices Exhibited at R. M. A. Show

Maker	Name of Product	Type or Style	System Used	Capacity	Price	Maker	Name of Product	Type or Style	System Used	Capacity	Price
American Electric Co., Inc.	Burns	750	Raytheon BH Tube	180 V. at 50 mls.	Not yet An'cd	The Sterling Manufacturing Co.	Sterling "A" Socket Power Supply	"A" Power Supply R-96	Raytheon "A" Cartridge and Sterling Transformer.	2 Amps. Max.	\$47.00
Murad Laboratories	Murad "A" Eliminator	None	2 Tungar Tubes	2 Amps.	\$60.00						Raytheon Cartridge with Raytheon Tube \$42.50 without Cartridge \$28.00
	Murad "B"	None	2-216B Tubes	180 V. at 65 mls. Also Eliminates "C" Batteries							\$4.00 additional
Acme Electric & Mfg. Co.	"A" Power Unit	APU-6	Tube	6-Volt "A" Battery and Rectifier Tube	35.00		Sterling 4 Volt "A" Power Supply	"A" Power Supply R-94	Tungar Bulb	Up to 10 Tube Sets	Tungar Bulb \$4.00 additional
	"A" and "B" Socket Power Unit	A-B-1	"	40 mls at 150 V. Has 6-Volt "A" Battery and Charger	67.50						\$64.50
	Universal "B" Supply	BE-40	QRS Tube or Raytheon B-H	40 M. A. at 150 V.	35.00		Sterling A-B-C Power Supply	A-B-C Power Supply R-100	Raytheon Cartridge for "A" and Raytheon B-H Tube for "B" and "C"	2 1/4 Amps. "B" Max. 180 Volts	Raytheon "A" rectifier \$4.50 additional B-H Tube \$6.00 additional
Gould Storage Battery Co., Inc.	Unipower	AC6HA	Electrolytic	0.3 to 1.5 Amps. 4 trickle rates. 1 high rate.	42.50						\$22.00
All American Radio Corp.	All American	A-8 Socket "B" Power	Raytheon Tube	35 Mils. at 180 V.	27.50						\$85.00
	"A-1" Constant "B" Power Supply				31.50						\$24.00
Also supplied for Greene-Brown Mfg. Co.	25 to 40 cycles and 50 to 60 cycles at				36.50						\$33.50
	Greene Power Units	Greene B-5-6-7	Tube	35 M. A. at 135 Volts	\$27.50		Sterling "B" Power	RT-41	UX213 or CX 313 Tube	130 V. at 20 Mils.	\$22.00
	Hi-Power	Greene "B" Hi-Power	"	55 M. A. at 180 Volts	30.00						\$8.00
	Super Power	Brown "B" Super Power	"	85 M. A. at 200 Volts	33.50		Sterling "B" Power	RT-81	B-H Raytheon	135 V. at 35 Mils.	\$24.00
Acme Apparatus Co.	Acme	E1B Power Supply	Raytheon Tube (1 to 12 Tube Sets)	110 V. 60 Cycle	50.00						\$8.00
		E3B Power Supply	Raytheon Tube (1 to 8 Tube Sets)	110 V. 60 Cycle	35.00						\$33.50
		E4B Power Supply	Raytheon Tube	110 V. 60 Cycle	35.00						\$6.00
		E2B Power Supply	DC-110-220 V.		25.00						\$49.00
Abcox Co.	Abcox "A" Power Unit	No Type Nos.	Electrolytic	2 Amps. 6 V.	32.50		Sterling Heavy Duty "B" and "C"	R-97	B-H Raytheon	180 V. at 50 Mils. 3 to 9 Volts "C"	\$6.00 additional
United Radio Corp.	Abcox Filter Peerless "A" Power	4 and 6 Volt.	Bulb	Filter only	19.50						\$32.50
Kodal Radio Corp.	Kuprox "A" Transifiers ("A" Battery Eliminator)	101	Disc (Dry) Rectifier	1 Amp. at 4 V.	\$28.50	Universal Battery Co.	Universal "A" Socket Power Unit	None	Westinghouse Rectox Dry Disc Rectifier Tubes up to 10	6 V. Any number of Tubes up to 40 M.A. at 180 Volts	\$45.00
		102	"	2 Amps. at 6 V.	29.50		Universal B-C Socket Power Unit	"	Raytheon B-H Tube	"C"—0 to 45 Volts	
		103	"	3 Amps. at 6 V.	39.50		Universal A-B-C Socket Power Unit	"	Rectox for "A" and Raytheon B-H Tube for "B" and "C"	6-V-C 180 Volts. B. 0 to 45 Volts "C"	72.50
	Kuprox Combination A-B-C Transifiers	106	Dry Disc Rectifier	"A" 2 Amps. at 6 Volts. "B" 45, 90, 180 V. at 135 M. A. "C" 1 Amp. 4 Volts. "B" 45, 90, 135 V. "C" 4-22 1/2 V.	57.50	Timmons Radio Products Corp.	Timmons Combination Power Amplifier and B Supply	"	UX 216B or CX 316 B and UX-210 or CX-310 Tubes	Up to 350 Volts. "B" without Tubes	70.00
		108	"	"A" 3 Amps. at 6 Volts. "B" 45, 90, 150, 180 V. "C" 4, 10, 22 1/2 and 40 V. 20 M. A. at 45 and 90 V.	80.00						\$32.50
		107	"	"A" 3 Amps. at 6 V. "B" 45, 70, 90, 150, 180 V. "C" 4, 10, 22 1/2 and 40 V.	97.50	Prest-O-Lite Battery Sales Corp.	Speedway Socket "B"	None	Tube Type	22 to 180 60 M.A.	\$32.50 or \$38.50 with Tube
	"B" Transifiers (Kodal)	60	"	45 and 90 V. 35 M. A. at 45, 90 and 180 Volts.	26.50						34.50
		161	"	45, 90 and 180 V. 100 M. A. at 45, 70, 90, 150, 180 V. "B" and 4-10-22 1/2 and 40 Volts "C"	54.50		Prest-O-Lite Trickle Charger and "A" Power	AZ	With Battery, Rectox Disc, Rectifier and Relay	6V. 6/10 Amp. Max. Rate (3 Rates)	
		110	"	45 M. A. at 45, 90 and 180 V.	39.50	A.H. Grebe & Co., Inc.	Grebe Socket Power	671	Tube	.8 Max Rate. 180 V.-B 0 to 40 V. "C"	36.50 50.00 without Tube
		116	"	45, 90, 150 and 180 V. 100 M. A. at 45, 70, 90, 150, 180 V. "B" and 4-10-22 1/2 and 40 Volts "C"	54.50	Stewart Battery Co.	Stewart Electric "A" "B"		Solid-Dry for "A" Tube for "B"	180 V. "B" 6 Volt "A" without Tube for "B"	\$63.00 without Tube
		114	"	45 M. A. at 45, 90 and 145 V. "B" also 4 and 22 1/2 V. "C"	37.50		Stewart "B"		Raytheon Tube B or B-H	180 V. "B" without Tube	29.00
		163	"	100 M. A. at 45, 90, 120 V. For D. C. Supply only	22.50		Stewart Super "A"		Dry Solid Rectifier	2 1/4 Amp. "A"	34.50
		120	"	35 M. A. at 45, 90 and 180 Volts	45.00	Interstate Electric Co.	Handy "A" Power		Storage Battery and Charger with Bulb	40 Amp. "A" Battery	\$42.50 Bulb \$4.00 additional
						Philadelphia Storage Battery Co.	Philco "B"		Philotron Unit	180 V. at 60 Mils.	\$39.00
							Philco "A-B"		Philotron Unit	6 Volt "A" and 180 Volt "B"	65.00

All prices are Eastern prices. 10% usually added on all sets west of Rockies.

Socket Power Devices Exhibited at R.M.A. Show

Continued

Maker	Name of Product	Type or Style	System Used	Capacity	Price	Maker	Name of Product	Type or Style	System Used	Capacity	Price
Julian M. White Mfg. Co.	White "A" Socket Power	Dry Element	6 V. 2 1/4 Amp.	Not an 'e'd	"	"	ABC Eliminator...	Raytheon...	6 V-A, 2 Amps.	64.50
American Bosch Magneto Corp.	Nobattery "A"	Dry	6 V.	\$58.00	"	"	"	"	180 V. B. without 45 V. C.	Tubes
"	Nobattery "B"	Tube	200 V.	42.00	Ashworth & Gallop	Western "B"	"B" Elim...	QRS Tube...	200 V. 50	39.00
The Wise McClung Co., Ltd.	Compo "A"	"Paste" Cells Trickle System	4 or 6 Volts. 2 Amps.		Grigaby Hinds Co.	Majestic	Super "B"	Majestic 100 Mil Tube...	50 M.A., 180 V.	29.50
"	Compo B-C	Raytheon B-H Tube	180 V. "B"		"	"	Master "B"	"	60 M.A., 200 V.	32.50
"	Compo ABC	Paste "A" Battery and Tungar Tube	4-6 V. 2 Amps. 180 V. "B" 40 V. "C"		"	"	Special Master "B" with 4 B Taps	"	60 M.A., 200 V.	32.50
The Webster Co.	Webster Bone-Dri "A"	A-7	Raytheon Cartridge	1 1/4 Amps	\$37.50 with Raytheon Cartridge	"	Majestic Ace	Model R	"	For Sets using McCullough A-C Tubes	35.00
"	"	A-10	"	2 1/2 Amps	46.50 with Raytheon Cartridge	"	"	Model S	"	For Sets with A-C RCA or Cunningham Tubes	35.00
"	Bone-Dri A-B Eliminator	A-B-7	Raytheon "A" Cartridge and Raytheon "B" Tube	1 1/4 Amps. for "A" 150 V. "B"	61.50 Complete	"	Majestic	"B" Rectifier Tube only	"	Tube only	5.00
"	Bone-Dri A-B Eliminator	AB-10	"	2 1/4 Amps. for "A" 200 V. "B"	70.00 Complete	Fansteel Products Co.	Balkite	A-B Model 6-180	85 Mils. Balkite Electrolytic	6 V., 2 Amps. For "A," 180 V. at 55 M.A. for "B"	5.00
"	Webster B-C	Little Giant B-C	B-H Raytheon	85 M.A. at 200 Volts. 0 to 45 Volts "C"	60.00 Complete	"	"	Balkite "A"	Balkite Electrolytic	6 V., 2 Amps. "A" Eliminator...	32.50
"	Webster Super "B"	"	"B" Raytheon Tube. Also for B-H Tube	180 B. 60 Mils	39.00 with B-H Tube	Silver Marshall Incorporated	Plug-In-B	650	50 Mils. at 180 V., 0 to 45 V. "C" Rias	UX213 or CX313 Tube.	34.50
"	Webster Economy "B"	"	"B" Raytheon Tube	180 V. 35 Mils	33.50 with "B" Tube	"	Unipac	660	"B" Supply and Push-Pull Power Amplifier	Tube	62.00
"	Webster Popular "B"	Open Model	"B" Raytheon Tube	180 V. 35 M.A.	31.00 Complete	Chargers					
Eagle Charger Corp.	Eagle Socket "B" Power	135	Raytheon B-H or QRS Tube	135 V. 40 M.A.	\$33.00 without Tube	Indiana Elect. Mfg. Co.	20-A	Raytheon Cartridge	21.00
"	"	180	"	180 V. 60 M.A.	43.50 without Tube	"	20-B	Bulb-2 Rate	10.00	High & Trickle
"	Eagle "A" and "B" Radio Power Unit	"	Raytheon B-H or QRS	180 V. 60 M.A. "A"	89.50 without Tube	"	20-C	Bulb	12.50	With Cut Off Relay
U. S. L. Radio Inc.	U. S. L. "A" Power	CA-60	Battery 40 Amp. 6 Volts	6 V.	\$25.00	American Electric & Mfg. Co.	Ator Trickle	Tube	\$17.50	(With Tube)
"	U. S. L. A-B Socket Power	A-B-135-60	Raytheon B-H and Storage Battery	40 M.A. 135 V., 8 V. "A"	65.00	"	AU-2 Universal	Bulb-2 Amp.	16.00
"	U. S. L. Socket "B" Power	RB-135-60	Raytheon B-H	40 M.A. at 135 Volts.	29.00	"	AT-2	Bulb	14.00	2 Rate Trickle 1/2 or 1 1/4 Amps.
"	"	RB-180-60	"	60 M.A. at 180 V.	39.00	Elkon Works	"B" Trickle Charger	Elkon Element	\$13.50	1 Amp. Max.
Valley Electric Co.	Valley "B" Power	Model 60	Raytheon	200 V. 80 M.A.	50.00 with Tube	"	"3" Charger	"	15.00	3 Amp. Max.
"	"	Model 40	"	For 5 or 6-Tube Sets	37.50 with Tube	"	"A" Power Unit	"	60.00	3 " "
"	Valley "A" Power Unit	Dry Power Unit	6 Volts, 2 Amps.	39.50	Acme Apparatus Co.	Acme	Acme A6 Charger	\$12.50	Raytheon "A" Unit 2 1/4 Amps.
Sentinel Mfg. Co.	Sentinel "A" Unit	Dry	6 V., 2 A.	40.00	"	"	Acme A7	18.00	Raytheon "A" Unit 5 Amperes
"	Sentinel B-C Power Unit	"	80 M.A., 180 V., 40 V-C	44.50	Kodel Radio Corp.	Kuprox	Trickle "B" Recharger	\$10.00	Low charge rate for recharging "B" batteries. .8 to 1 Amp.
"	Sentinel A-B-C Power Unit	"	6 Volts "A" 2 Amps. "B"-80 M.A. 180 Volts	79.50	"	"	Trickle Charger "Disc Rectifier" Charger	10.50	.8 to 1 and 2 1/4 to 3 Amp. rates.
Atwater Kent Mfg. Co.	"B" Power Unit	Type R	Own Tube	135 V.A., 60 M.A.	50.00	Stewart Battery Co.	Two Rate Charger	Dry Solid Type	\$12.00	1/2 or 2 1/4 Ampere
Bremer Tully Mfg. Co.	B-T	"B" Power	B-H Raytheon Tube	150 V. at 50 M.A.	37.50 without Tube	"	Hi-Rate Automatic "A" Charger	"	19.08	2 1/4 Amperes.
Triple A Specialty Co.	Silver Beauty	"A" Power	Own Make Dry Element	6-Volt, 2 Amp	39.50	Apco Mfg. Co.	Apco Automatic "A" Charger	Dry Copper Disc	\$16.50	1/2 to 1 Amp.
"	"	"	"	6-Volt, 2 1/2 Amp	43.50	Interstate Electric Co.	Handy Trickle Booster	Dry Raytheon Cartridge	\$10.00	1/2 to 2 Amperes.
Chas. Freshman Co., Inc.	Freshman Power Apparatus	Universal A-B-C Power Supply	Own (uses RCA or Cunningham Tubes)	180 Volts Max.	49.50	Johnson Motor Products Co.	"Charg-a-Matic"	Dry	\$12.75	1 to 1 1/4 Amperes.
"	"	B-C Power Supply	"	180 Volts "B" 45 Volts "C"	45.00	The Webster Co.	Webster "Bone-Dri"	Dry Raytheon Element	\$10.50	2 1/2 Amperes. Element \$4.50 additional
Electric Research Labs.	Erla	"A" Converter	Raytheon Cartridge	6 V., 2 Amp.	39.50	Valley Electric Co.	Valley Automatic Charger	Dry Raytheon Element	\$16.50	1 1/2 or 2 1/2 Amperes
"	"	B-C Eliminator	Raytheon Tube	180 V., 60 M.A.	40.00 with Tube	"	TBC Tube Type	Rectigon	15.00	2 1/2 or 5 Amps. less Tube

All prices are Eastern prices. 10% usually added on all sets west of Rockies.

Loudspeakers Exhibited at R. M. A. Show

Maker	Name or Style	Type	Size	Price	Unit	
Trimm Radio Mfg. Co.	Trimm	No. 28 Concerto Cone	14"	\$10.00	Balanced Armature	
		No. 38 Concerto Grande Cone	17"	16.00		
The Radio Cabinet Co.	Orchestrion	Orchestrion De Luxe Horn		29.50		
		Orchestrion Table Model Reproducer		35.00		
		Orchestrion Grand Cabinet Reproducer		50.00		
Stewart-Warner Speedometer Corp.	Stewart-Warner	Model 425	Drum High 13 1/4", Diam-eter 11 1/4"	25.00	Single Balanced Armature	
		Model 420	Drum, Diam-eter 9"	17.50		
Molded Wood Products, Inc.	Fairfax	No. 601	Cab. Speaker High, 38" Wide, 33 1/4"			
		No. 602	Cab. Speaker High, 38" Wide, 25"			
Teletone Corporation of America, Cannon & Miller Co., Inc.	Teletone	Tip Table Model Cone			Floating Armature	
		Cannon-Ball	Blue and Gold No. 2 Cone	16"	\$ 9.00	Balanced Armature
			Giant Cone Kit Wall Model Cone	38"	9.00	
			Table & Wall Type Mod. 3 Cone	18"	15.00	
			Table & Wall Type Mod. 5 Cone	18"	12.50	
Diamond "T" Radio Mfgs.	Diamond "T" Radio	Mod. 4 Cone	High, 29" Wide, 28" Deep, 18"	40.00		
		Duo-Tone Speaker Cab.				
Atwater-Kent Mfg. Co.	Atwater-Kent	Model E Cone	14"	\$30.00	Own Floating Diaphragm	
Bremer-Tully Mfg. Co.	B-T	Cabinet Tone	8"	35.00	Own Make	
Reichmann Co.	Thorola	No. 11 Cone	16"	10.00	Balanced Armature	
		No. 18 Cone	14"	25.00	Non-Adjustable	
F.A.D. Andrea Inc.	Fada	315A Table Cone	17"	25.00	Balanced Armature	
		415-B Table Cone	22"	35.00		
		425-B Floor Cone	22"	50.00		
		W. 15-B Wall Cone	22"	35.00		
Utah Radio Products Co.	Utah	Attach to Piano Sound Board	Unit only	10.00	Own	
		Junior Cone	15 1/4"	10.00		
		Superflex Cabinet Speaker	8 1/4" x 8" 36" x 27 1/4"	10.00 75.00		
Splitdorf Radio Corp.	Splitdorf	Cone Tone	22"	35.00	Own	
		Bell Tone	Horn	14"	20.00	
Spartan Elec. Co., N. Y.	Spartan	Pyramid Paper Diaphragm	14"	\$18.00	Balanced Armature	
			18"	25.00		
O'Neil Mfg. Co., N. Y.	The O'Neil	Cone	24" 14"	\$30.00 \$ 8.50	Balanced Armature	
			18 1/4" 13"	12.75 29.00	Balanced Armature	
Temple, Inc.	Temple	Drum	18"	49.50		
		Senior Drum Cabinet Speaker in Walnut Cab.	18"	65.00		
All American Radio Corp.	All American	Cone	13"	25.00	Adjustable	
		Melofonic Model M	Cone	14"	28.50	Tensile Tension, Balanced Armature
Acme Apparatus Co.	Acme	Cone K-1	13"	25.00	Free Edge	
		Cone K-3	11"	14.50		
		Cone K-2		38.00		

Maker	Name or Style	Type	Size	Price	Unit
Stevens & Co., Inc.	Stevens	Conoidal Curved Model A-27	14 1/2"	18.50	Balanced Armature
		Conoidal Curved Model B-27; also wall model BW-27	17"	25.00	Tensile Tensioned
Newcombs Hawley, Inc.	Burtex Diaphragms on all these speakers.	Model 53 Cabinet, 86-inch Tone Chamber	33" x 28 1/4"	65.00	Baldwin Unit
		Model 55, 86-inch Tone Chamber	34 x 36 1/4"	75.00	
		Model 56 with doors	34 x 36 1/4"	85.00	
		Model 57 Large console cabinet with space for radio set up to size 28"	High 44" Wide 36 1/4"	125.00	
		Drum-Type winding tone chamber	15"	32.00	
Mohawk Corp. of Illinois	Mohawk	Pyramid Gothic Cab.	12" x 14"	25.00	Actuating Balanced Armature
United Radio Corp., Newark	Peerless	Gothic table Cabinet	10" x 13"	35.00	Free Edge Floating Periphery
Crosley Radio Corp.	Musicoons	Cone	12"	9.75	Own
		Tilt Table Musicoons	Pedestal Cone	16"	27.50
Magnavox	Magnavox	Electrodynamic Cone	Low Boy cabinet	\$160.00	Magnavox Floating Armature
		Magnetic Cone	8"	27.50	A.C. operated
A.H. Grebe & Co., Inc.	Grebe	20-20 Cone	20"	\$45.00 \$35.00	Unit with B Eliminator without Cab.
		RCA 100-A	8"	35.00	Magnetic Unit



Temple Drum Speaker with Balanced Armature.

All prices are Eastern prices. 10% usually added on all sets west of Rockies.

Some of the New Factory Built Models

Freshman A. C. Receiver

The new Freshman a. c. set has three stages of tuned r. f., detector, and two stages of audio. By means of special vacuum tubes, raw a. c. is used as the filament supply, rectified and filtered a. c. supplying plate and grid voltages. Tuning is done with a single control. The receiver is installed in a walnut console with built-in loud speaker and power unit operated directly from the 110 volt lamp socket.

Among the several unique provisions in this new set are the Type 28 and 26 a. c. filament tubes. These tubes draw .35 ampere each at 15 volts, which is supplied from a step-down transformer. The heater element is a carbon filament which is encased in a metal tube coated with the oxides of the rare earths. These emit the electrons which pass through the grid to a concentrically wound plate. This heater element has been found to function satisfactorily with as high as 30 volts and as low as 10 volts.

The circuit diagram shown herewith is almost self-explanatory. The r. f. transformers are wound on 1 1/4 in. forms with 16 turns in the primary of the first and third and 14 turns in the primary of the second, which is unstabilized. Oscillation in the first r. f. tube is prevented by a 350 ohm fixed resistance in its plate lead. In the third tube oscillation is controlled by a 730 ohm series resistance connected in series with a .0007 mfd. variable condenser and the primary of the inductive coupling, this condenser being adjusted once for all when the receiver is assembled.

The three tuning condensers are operated from one dial by a series of metal bands. Fine tuning is accomplished with a midget condenser shunted across the antenna coil. Other details are self-evident in the circuit diagram.

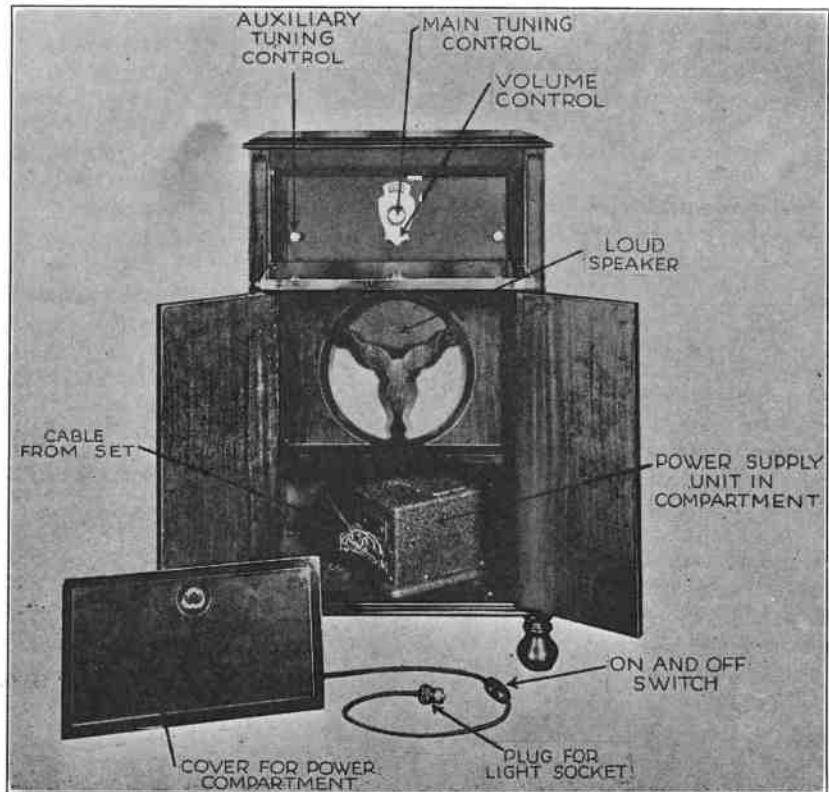

Freshman Six-Tube A. C. Receiver.

Sonora

The Sonora line has two chassis, a six tube and a seven tube. They may be operated either by batteries or by the Sonora a. c. power plant. The six tube chassis is available either in a table cabinet or in two console models. The seven-tube is offered only in a console fitted with a loop. The variable condensers and coils are separately shielded in individual metal housings. The use of UX171 — CX371 tube is standard in the last stage.

Freed-Eisemann

Freed-Eisemann Radio Corporation showed seven new models, four 6-tube, one 7-tube and two 8-tube sets. Model NR-8 is a two-control Neutrodyne with three stages of tuned r. f., detector and two stages of audio. It is housed in a mahogany cabinet 10 by 19 3/4 by 10 1/2 in. and is designed for antenna connection with variometer tuning. Volume is controlled by a rheostat in the r. f. filament circuit.

Models NR-9, NR-11, and NR-66

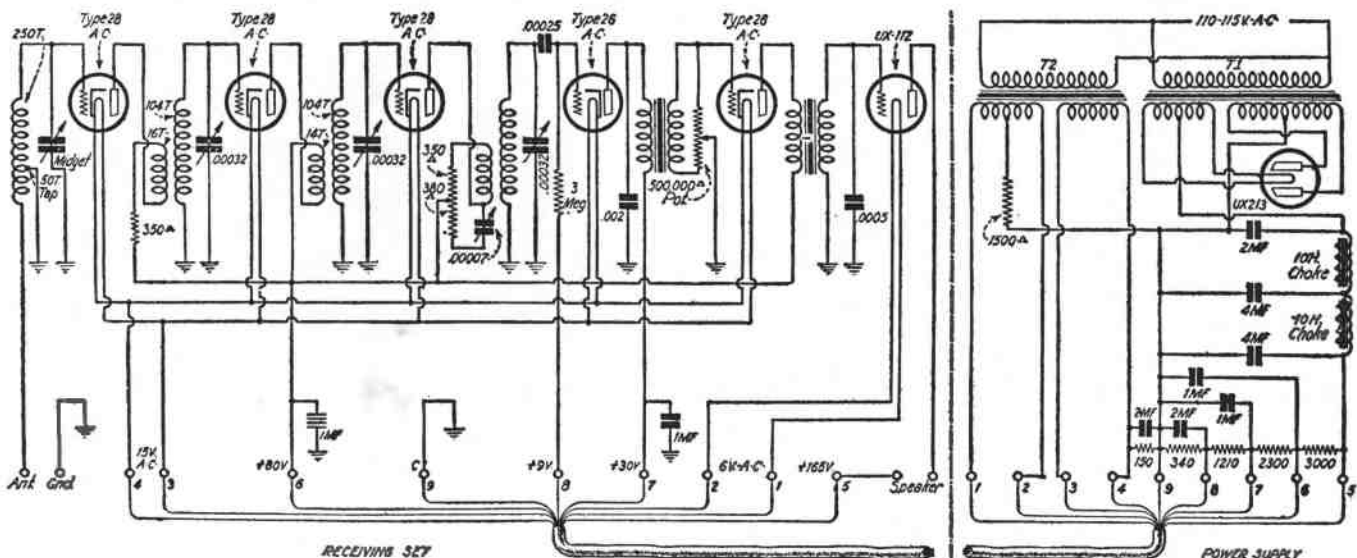

Circuit Diagram of Freshman A. C. Receiver and Power Supply.

are single-control instruments which are otherwise similar to the NR-8 model except that the NR-11 is operated by an "A B C" power unit which is supplied with the receiver and uses an output transformer, and that in the NR-66 the individual stages are shielded. The NR-66 also has an illuminated dial and the NR-9 and NR-11 a pilot light.

The NR-77 is a single-control 7-tube Neutrodyne with four stages of tuned r.f. adaptable for use with either aerial or loop. It has individual stage shielding, illuminated dial, and output transformer. The cabinet is 10½ x 23 x 13 in.

Models 800 and 850 are single-control 8-tube Neutrodynes with four stages of tuned r. f., the former being housed in a table cabinet and the latter in a console. They have a pilot light, output transformer, individual stage shielding, and may be connected to either aerial or loop.

Radiolas

Two new A. C. operated models were exhibited by the Radio Corporation of America. Both are superheterodynes using seven series connected UX-199 tubes and a power tube in the last audio stage. Socket power is used through UX-281 rectifiers and a VX-876 voltage regulator amplifier. An a. c. switch alongside the loudspeaker grilled opening turns on the current and illuminates the tuning dials when the doors are opened

and turns off the current when the doors are closed.

Radiola 30-A has an antenna coupler with connections for aerial and ground in the rear of the receiver. A UX-171 power tube operates a new model 100-A loudspeaker enclosed in a special casing to prevent resonant effects. It is enclosed in a distinctive walnut cabinet 42½ in. high, 29 in. wide, 17 3-4 in. deep, weighing 127 pounds.

Radiola 32 uses an enclosed loop which is tuned by the vertical dial alongside the loudspeaker opening. A UX-210 power tube operates a built-in 104 loudspeaker. The beautifully grained walnut cabinet stands 52 in. high, 72 in. wide, and 17 3-4 in. deep, weighing 213 pounds.



Radiola 16

The new Radiola 16 has a uni-control six-tube receiver with three stages of tuned r. f. detector, and two stages of audio, taking five UX-210A tubes and one UX-112. It is intended for battery operation and connection to an outside aerial. Like the Radiola 16 it has but three control knobs.

The new Radiola 17 uses a. c.

filament tubes whose plate and grid voltages are obtained from a built-in power unit using a UX-280 full wave rectifier. The new UX-226 tubes are used in the three r. f. stages and in the first a. f. stage. A UX-227 is used as a detector and a UX-171 in the last audio stage. There are three control knobs on the panel, one for tuning, one for controlling volume, and one for turning the power on and off. This receiver uses an aerial.

Marti Electric Power Radio

The Marti is a six-tube set with three-dial control. By the use of Kellogg a. c. tubes its tube filaments are operated directly from the a. c. circuit, plate current being

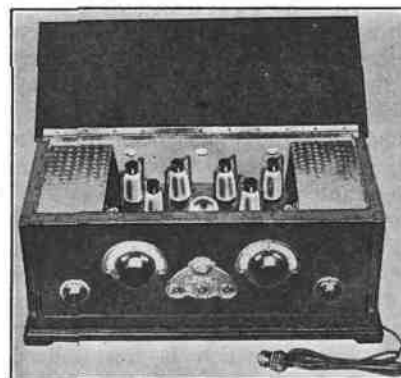

furnished by a "B" eliminator installed in the cabinet. The cabinet is 24 by 11 by 10 in. and the net weight is 39 lbs. It has illuminated dials and is available either in a table cabinet or console model.



Radiola 30-A.



Radiola 32.

Thorola

The new seven-tube Thorola has three stages of tuned r. f., detector, and three stages of transformer coupled audio. The four tuning condensers are operated from a single dial through gears. A small compensating condenser in the antenna circuit is controlled by a panel knob as is also a rheostat controlling the r. f. amplification and volume. The coils are of the enclosed field type to prevent inter-coupling and are wound on bakelite, being designed for accurate matching and permanency of adjustment. Linked connector plates and cabling are used in wiring. The condensers are shielded

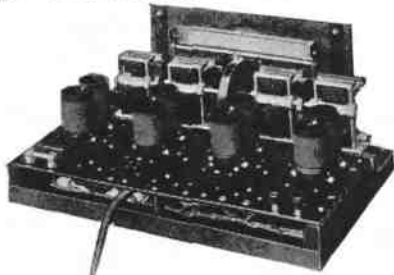

Thorola Seven-Tube Chassis.

with copper-plated zinc (not shown in picture). The circuit is designed to give high amplification on all wavelengths.

The chassis illustrated herewith is mounted on rubber cushions in two models. No. 61 is a highboy and No. 62 is a console. The former has a No. 17 Thorola loudspeaker unit with an orthophonic horn having an extremely long air

column. The latter has two orthophonic horns, one unit being pitched higher than the other.

The Grebe Synchronphase Seven gives extreme selectivity on both long and short wave lengths in the broadcast band through the use of ingeniously devised tube isolating circuits and space-wound Litz binocular coils in the five tuned stages. The five tuning condensers are operated by a single projecting dial. All its units are mounted on an aluminum deck through which

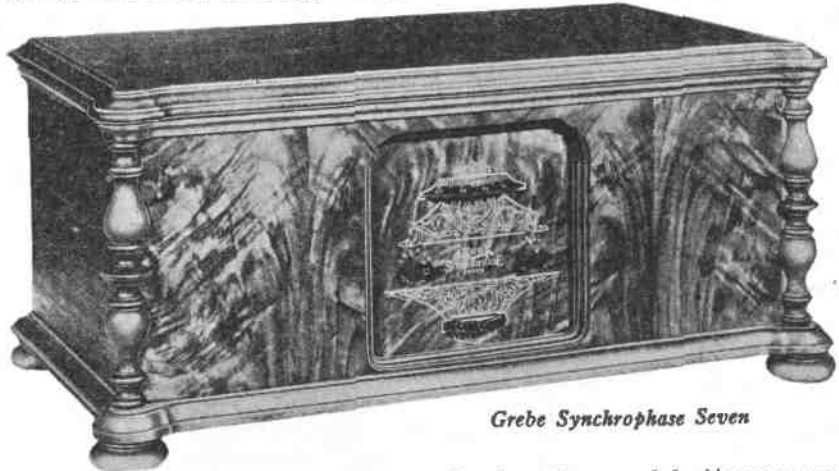

Grebe Synchronphase Seven

the terminals project, so that all wiring is concealed underneath. There are two stages of audio frequency amplification with a power tube in the last stage. The system is designed to deliver a maximum of uniform undistorted power to the loudspeaker. The last stage is provided with a "Colortone" which

loudspeaker and battery space. In other models, such as the Baronet or the Viking, a table-mounted or console cabinet houses the instrument. Each model uses a single dial station selector with separate vernier adjustment, has two stages of tuned r. f., detector, and three stages of audio. The Commander model has a folding loop for local reception and antenna connection for distance. All models are of rugged mechanical construction.



Thorola Console with Two Orthophonic Horns.

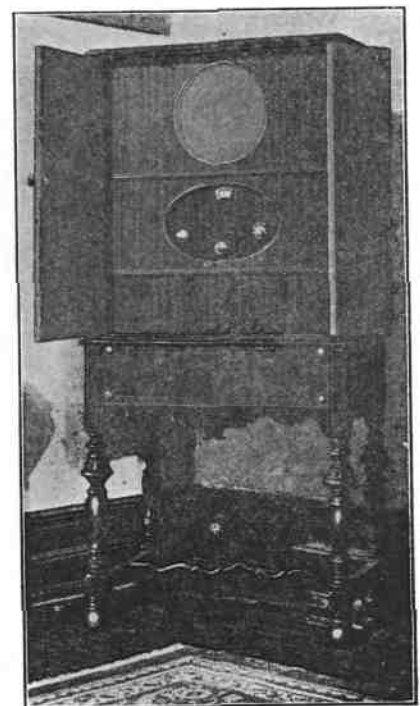

King Radio Co. Chevalier Model

Bosch Receivers and Accessories

The Bosch line of new receivers consists of six models: a 5-tube model in either table cabinet or console, a 6-tube chassis in table cabinet or in a console either with or without speaker, and a 7-tube chassis in console with speaker and loop. Each model is distinctively housed in a beautiful cabinet designed to harmonize with home furniture.



Bosch 6-Tube Table Model

Each model has a single station selector with clarifier and volume control to complete the tuning adjustments. The station selector is graduated in kilocycles and is illuminated from the rear to give "line-of-light" tuning. The clarifier is an antenna tuner which automatically compensates for various antennas and for the different frequency characteristics at the two ends of the broadcast band. The volume control is a rheostat in the plate circuit of the r. f. tubes.



Bosch 6-Tube Console

The r. f. stages are individually balanced and shielded under the R. F. L. patents. The 7-tube model has four r. f. stages, the 6-tube three, and the 5-tube

two. The gang condensers of the 7-tube model are operated by a double-thread worm and worm wheel without back-lash. Those of the 6-tube models are worked by a pinch wheel on the station selector countershaft and a disc on the main shaft of the condenser gang, which is counter-weighted to insure easy tuning action without strain. The 5-tube model has a drum-type control directly connected to a condenser shaft.

The secondaries of the r. f. transformers are wound on thread-grooved insulating forms to insure uniformity and rigidity of winding. The primary and balance windings are carefully located over the secondaries and insulated therefrom with heavy paper. The assembled

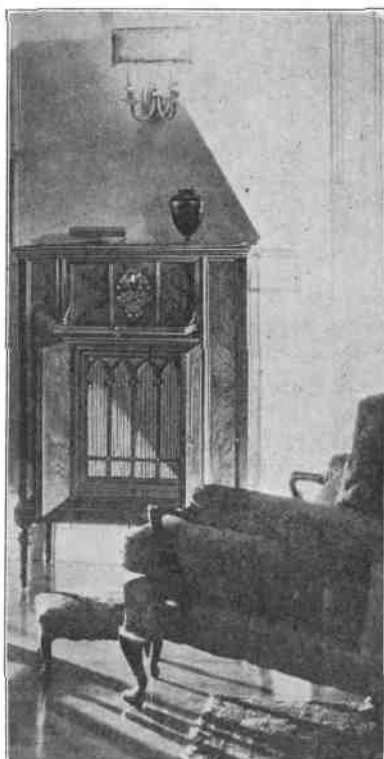

Bosch 7-Tube Console

coil is centrally mounted and completely surrounded by a heavy copper shield. The wires from the various windings are brought directly through the shield insuring minimum length at points convenient to the portion of the circuit with which they are connected. These wires are carefully insulated from possible contact, with high grade varnished cambric tubing. Great care is used in testing and electrically matching the coils used in the different stages of the receiver since it is necessary that all of the coils in any one receiver be almost exact duplicates of each other.

Due to the many precautions taken in manufacture and assembly these sets have great selectivity and sensitivity. Tone quality is provided in a well-designed audio amplifier with a power tube in the last stage. Those models having a built-in speaker use the Bosch Re-creator and output transformer or Powertrol.

All models are adapted for operation from either batteries or socket power. For the latter purpose the Bosch *A* and *B* power units are available either separately or in combination. The *A* unit does not contain a storage battery and delivers ample current for parallel-connected filament operation.

Kolster Radio

Two new Kolster models were shown. One is a six-tube console with a combined built-in power cone and *B* supply



Kolster Six-Tube Console

unit. The other is a console power cone requiring no batteries. The former is a single control set housed in a walnut cabinet with maple overlays, 53 in. high, 27 in. wide, 18½ in. deep. Ample space is provided for either storage battery and charger or Kolster *A* supply unit. The latter is a one-stage power ampli-

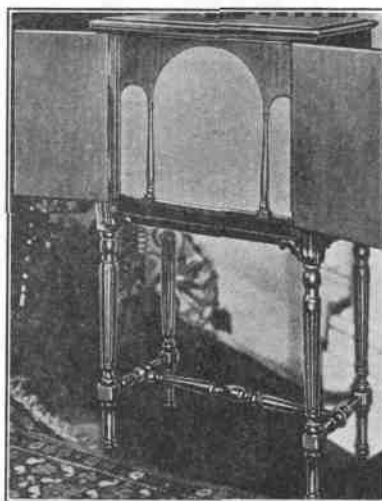

Kolster Power Cone

fier and loudspeaker together with a full wave rectifier and filter using two 216 B tubes and voltage regulator tubes. It is enclosed in a walnut cabinet 42 in. high, 25½ in. wide, 19 in. deep.

Stewart-Warner

The Stewart-Warner display included two single control 6-tube chassis models available either in a table cabinet or in a console with built-in loudspeaker and space for batteries or power plant. The Model 500 chassis has two tuned

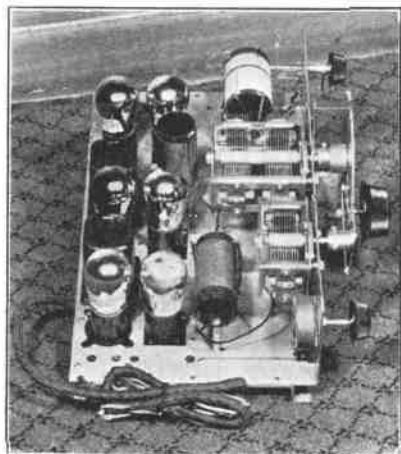

Stewart Warner Model 500 Chassis.

stages and one untuned stage of r. f. amplification, together with detector and two stages of transformer coupled audio. It is designed for antenna connection and has an auxiliary control to be adjusted to the particular aerial used. Tuning is accomplished by a locomotive type of driving links that give positive condenser rotation without lost motion. The filament switch is combined with a volume



Stewart Warner Model 520.

control. Control of filament voltage is automatic. The a. f. system used two "88 note" Stewart-Warner transformers and a power tube in the last stage. The walnut table cabinet is Model 525 and has an illuminated dial graduated in wavelengths. The walnut console,

Model 520, is similarly fitted and also has a Stewart-Warner "organ voiced" reproducer mounted behind a decorated metal grille in the lower half of the front panel.

The circuit and parts of the Model 700 chassis are similar to the Model 500 except that it is shielded and uses C battery instead of gridleak and condenser in the

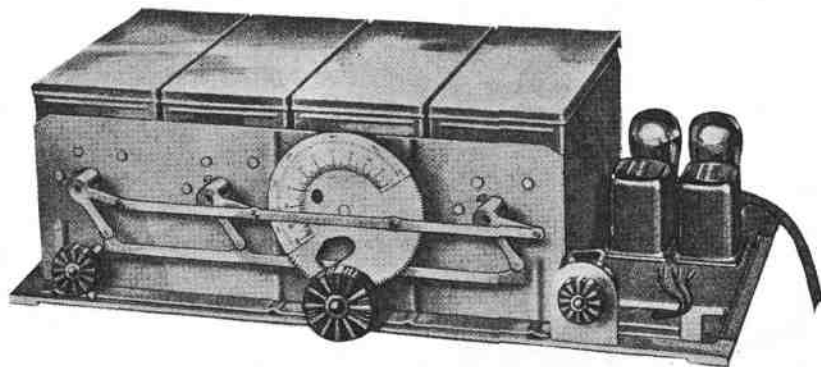

Stewart Warner Model 700 Chassis.

detector circuit. It uses a resonance balance method to check oscillation and to give uniform amplifi-



Stewart Warner Model 705.

cation throughout the broadcast band. It likewise is obtainable as table cabinet in Model 705 or as a console in Model 710.

Stromberg-Carlson

The Stromberg-Carlson No. 744 is an elaborate instrument combining a radio receiver with an electrically operated phonograph. The radio set employs a seven-tube circuit, including a UX-210 tube in the last stage. It has double shielding, each coil being inclosed in a cylindrical copper shell and each r. f. stage being further shielded in a rectangular copper



Stromberg-Carlson No. 744.

box. This is intended to insure stability, selectivity and efficiency. Reception is accomplished by means of a loop concealed within the cabinet. Of the two knobs on the panel, one is for the single control tuner and the other for volume control. The cabinet houses a complete power plant for a. c. operation without batteries or liquids.

The phonograph is electrically driven and has an automatic record stop and electro magnetic pick-up. The audio system of the receiver amplifies the phonograph output.

The new Kellogg A. C. Receiver is a seven-tube inductively tuned set, operated direct from any light socket supplying A C 110 volt, 60 cycle current. It is equipped with six Kellogg A C tubes and a Kellogg A C Power tube. It has four stages of radio frequency, a detector and two stages of audio. It is completely shielded; has extremely high amplification, is very selective and has fine tone quality. The controls are three—a wave zone setting, a selector dial and a volume control. This new Kellogg A C set is sold complete with tubes and built-in A, B and C power. The console model includes a reproducer with extra long air column.

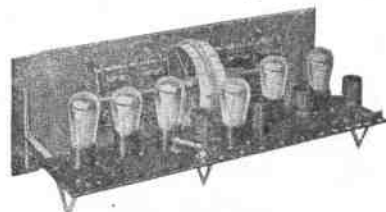

Premier Chassis

Premier

The Premier 6-in-line is a 6-tube chassis with a single drum control which is convertible to two dial control within 30 seconds without wiring change. On the panel appears only the metal dial plate, whose lower portion also contains a filament or volume control knob. This set has 3 r. f. detector and two transformer coupled a. f. stages. It may be operated either with batteries or

eliminators. Provision is made for either aerial or loop connection. Every movable part is mounted.

The Simplex six tube set is operated entirely from an a. c. current lighting socket without the use of any batteries. Power is supplied through a built-in power unit employing a Raytheon tube for rectification, and a step down transformer delivering three volts to the filament of the tubes. The B and C supply is handled through a filter circuit, the entire power supply built in as a part of the radio set. It has single control with dial calibrated in station wave



Simplex Six-Tube Electric

lengths. The entire assembly is housed in a cabinet with detachable legs. Volume control is by voltage variation on radio frequency plates, the plate current drain being 19 mills. A built-in light socket aerial is provided. The cabinet dimensions are 36 in. high, 34 in. wide by 14 in. deep.

Apex Technidyne

The Apex Technidyne is a new single-control receiver made in two



Apex Technidyne 7 Tube Console.

models. One is a seven-tube set for antenna connection and is housed in a console with built-in loudspeaker. The other is a nine tube circuit for loop connection, the loop being concealed in the highboy which houses the set and the loudspeaker.

Fada

The Fada line of new models include six, seven and eight tube types, all with centralized control of two tuning dials and a combination volume control and "on-off" switch. Each is shielded and assembled on a pressed steel chassis.

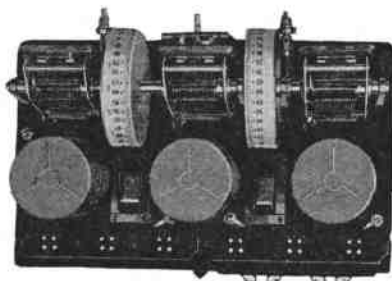

Chassis of Fada Special

The Fada Special is a table cabinet model of a 6-tube set with three stages of tuned r. f. amplification and intended for antenna operation. The seven tube model with four r. f., detector and two a. f. stages is available either in a table or console cabinet, each being equipped with a folding loop and also being adaptable to antenna connection. Each stage is individually shielded. The eight-tube model also comes in either a table or console cabinet and differs from the seven tube in having three stages of a. f. amplification and a toggle switch on the front panel for shifting from 7 to 8 tubes.



Fada 8 Console

Crosley

The newest Crosley receiver is the Bandbox, which comes in two models, 601 for battery operation and 602 for a. c. operation. Both are 6-tube sets with three stages of tuned r. f. detector, and two stages of transformer coupled audio, the last stage taking a power tube. They are completely shielded, non-oscillating and non-radiating. Tuning is accomplished with a master station selector and two auxiliary controls. The frosted metal cabinet, 17 1/4 in. long, 7 5/8 in. deep and 5 1/2 in. high is readily removed so that the chassis can be installed in one of three art furniture models. In the 601 model the volume control and filament switch are combined.

The model 602 (a. c.) uses four UX-226, one UX-227 and one UX-171 tube. Power is supplied by a separate Crosley a. c. unit using a UX-280 rectifier for plate supply and low voltage a. c. for filament

(Continued on page 87)



Crosley Bandbox

New Kits and Circuits for the Radio Builder

The 1928 Infradyne

THE new model of the infradyne is marked by the addition of a "front end" to the infradyne amplifier unit developed by Sargent and Rayment. This front end consists of a shielded two-stage tuned radio frequency amplifier, a control panel, metal chassis and a shield for the entire set. This equipment, together with the builder's choice of audio frequency amplifier can be quickly and easily assembled by a novice able to use a soldering iron, screw driver and pliers.

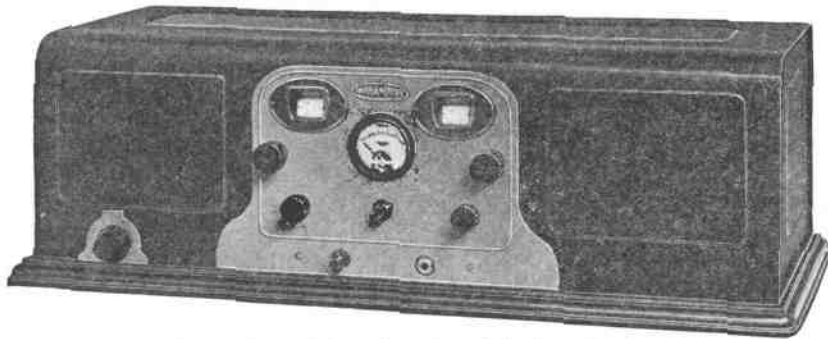

Front View of Complete New Infradyne Receiver.

This gives a ten-tube set which is unsurpassed in selectivity and sensitivity for long distance work, but which by the turn of a switch is available as a single-control five-tube set for local use. In fact the equipment is to be marketed separately for the latter use.

The r. f. circuit consists of a three-gang Remler variable condenser with fixed trimmers attached, the new Remler r. f. coils with coupling device geared to and operated by the condenser shaft (permitting of proper r. f. amplification over the entire broadcast wave band), sockets, condensers and resistors. This unit is housed in a completely shielded copper can, highly finished. Each r. f. stage compartment is individually shielded. The shield plates run between the three gangs of the variable condenser. The coupling of the r. f. coils is compensated for in the factory before the unit is shipped.

By this method it is now possible to accurately match the coils in the r. f. circuit with each gang of the variable condenser, eliminating the use of the trimmer condensers entirely. The coupling can also be varied for "loose" or "tight" by merely moving the r. f. coils up and down on a center shaft of brass, extending down through the coils. For extreme selectivity the coils are lifted upward—away from the coupling coil. For broader and less selective tuning the coils are brought closer together. The new Remler illuminated drum dial is attached directly to the condenser shaft.

The difficulty experienced with last

year's infradyne in properly matching the r. f. coils with the gangs of the variable condenser is now eliminated. The secret of success of the infradyne is in a properly balanced and well designed front end. The vacuum tubes are enclosed in the shielded can of the r. f. unit. The top of the can can be easily removed for insertion of tubes or inspection of parts of the r. f. circuit.

Another improvement vital to the easy handling of the r. f. circuit is the addition of a variable antenna coupler. This coupler is attached to the metal

copper cabinet into the space provided in the console.

Another illustration shows the metal chassis of the new infradyne with the control units mounted in the center. This metal chassis is stamped and punched to accommodate the various units. All holes for the wiring are drilled in the proper places. The sockets for the detector and oscillator tube, audio and power tube, are built into the metal chassis. Loud speaker terminals are attached to the rear of the metal chassis, as are the connection posts for the antenna and ground. Holes are bored in proper place for slipping through the current supply cable.

The Remler variable condenser for tuning the tapped inductance is attached to the Remler illuminated drum dial. The two tuning dials are mounted directly on a "unit control panel." This unit control panel accommodates the voltmeter, rheostat and switch holes and a switch for converting the receiver from a five-tube r. f. switch to a 10-tube infradyne—merely by a simple throw of the switch. The set then becomes a universal receiver. A 5-tube set for the housewife with only single dial control—or, by the snap of a switch, a 10-tube receiver for dad or son for breaking distance records at night.

A plug for headphones is on the bronze unit control panel. This is provided for the "fisher" who wants to use headphones for bringing in the hard-to-get stations. The audio unit sets directly alongside the condenser for tuning the tapped inductance. The audio tubes are on the extreme end of the chassis. Silver Marshall audio transformers are used.

Directly behind the audio amplifier and the controls is the Infradyne amplifier. No change has been made in this unit. The wires from the various units are run through holes in the chassis to the bottom of the chassis and most of the wiring is therefore invisible. A colored wiring chart will be used in wiring.

All the critical adjustments of the receiver have been eliminated.

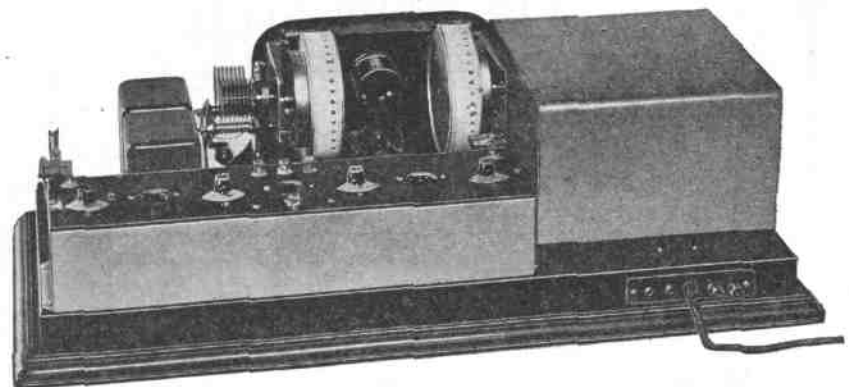

Rear View of Infradyne Panel and Chassis.

THE LEUTZ UNIVERSAL TRANSOCEANIC

THIS is a nine tube set employing four stages of tuned r.f., detector, three stages of audio, and one power stage. The tuning range is ordinarily from 200 to 560 meters. This can be extended down to 35 meters and up to 3,600 meters by means of plug-in r.f. transformers. It is adapted to use either antenna or loop aerial. As may be seen in the picture, all stages are completely shielded.

Five variable tuning condensers are provided, one for each of the four r.f. stages and one for the detector. Each may be individually operated by a tuning control which projects through the front panel. If preferred two adjacent condensers may be operated by one tuning control by tightening a screw which holds them together or all five can be operated simultaneously with a single control. When four dials are used simultaneously three compensating resonators are provided to correct errors.

The antenna circuit is adjusted to maximum efficiency by means of a variable series antenna condenser which adapts the receiver for use with aerials of different length.

By means of a voltmeter and nine point switch all A, B and C voltages from 0 to 500 are read directly. A milliammeter can also be connected to the common negative B terminal to measure the plate current taken by any tube. Any desired B voltage can be applied to any tube, as there are 20 binding posts at the rear of the receiver.

The tubes recommended for use in this set are four UX201A tubes for the r. f. amplifier, UX200 for the detector, one 201A and two high-mu for the audio amplifier and UX 210 with 350 volts for the power stage. The audio amplifier uses both transformer and resistance coupling. When the voltage

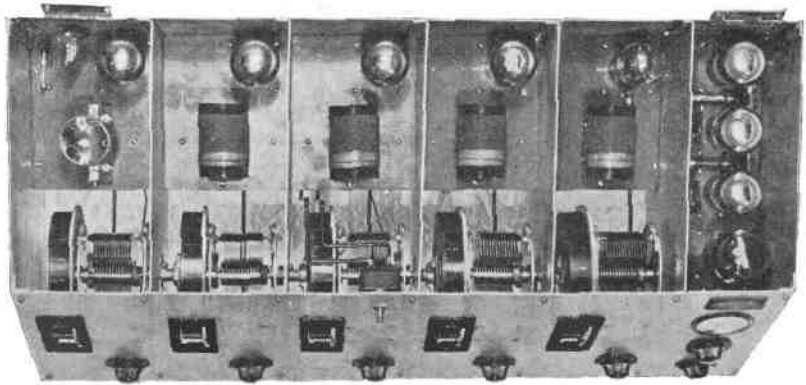

Leutz Universal Transoceanic.

is limited to 180 a UX171 may be used in the power stage.

The entire receiver is 27 in. long, 8 1/2 in. high and 13 1/16 in. deep at the bottom. It is designed especially for long distance reception, being exceedingly selective and sensitive. It is marketed in either factory built or in kit form. Either batteries or socket power devices may be used with it.

The Leutz B power pack used as an accessory to this set supplies 400 to 500 volts for the power tubes, 100 to 150 volts for the audio amplifiers, 45 to 100 volts for the r.f. amplifiers, 16 1/2 to 22 1/2 volts for the detector, 7 1/2 volts a.c. for the power tube filament and rectifier tubes and 30 to 45 volts C battery for the power tube. It is equipped with self-healing condensers having a total capacity of 19 mfd. Either one or two UX216 B rectifier tubes are used.

The Camfield Super-Selective Nine is a nine-tube receiver intended to give accurate 10 k.c. separation on all frequencies in the broadcast spectrum. It is built for antenna connection, using a band-pass filter with two stages of tuned radio frequency, two stages of intermediate frequency and two stages of audio frequency amplification. The instrument has three tuning controls, one operating a single antenna-tuning condenser, one a two-gang r. f. tuning condenser, and one a single intermediate frequency tuning condenser. Volume control is accomplished with a 6-ohm rheostat in the filament circuit of the r. f. amplifier tube. By means of a panel switch the set may be converted from a 9-tube to a 5-tube 2-control receiver.

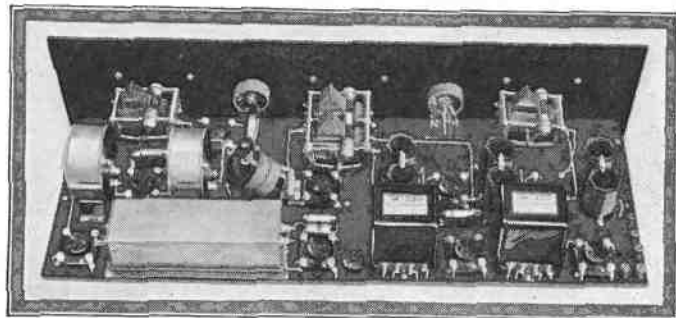

Camfield Super-Selective Nine.

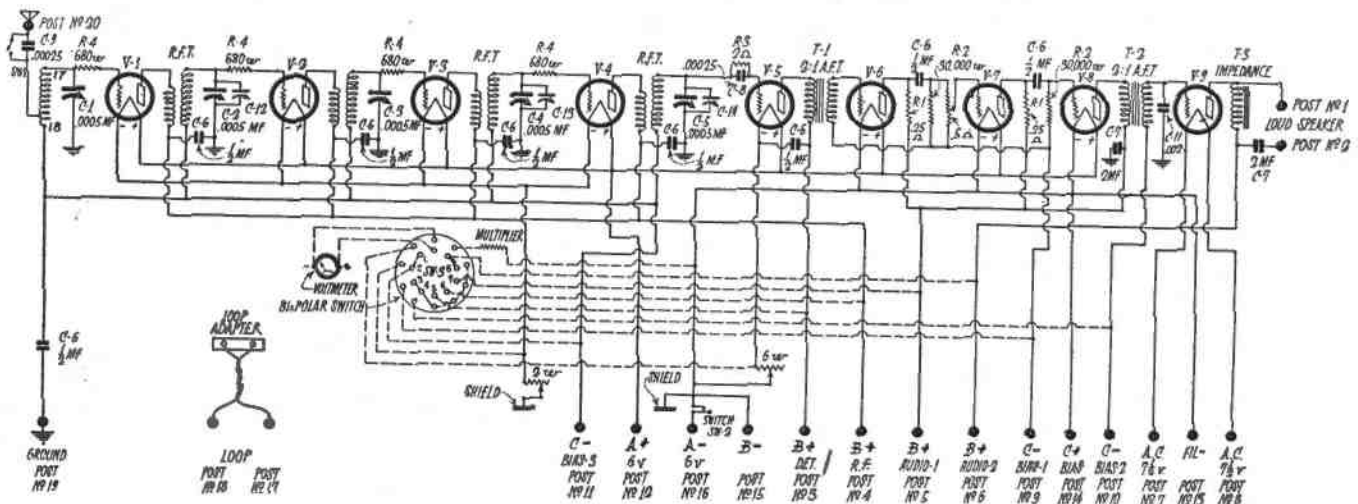

Circuit Diagram for Leutz Universal Transoceanic Assembled Set.

Vacuum Tubes Characteristics

NEW A. C. FILAMENT TUBES CX-326—UX-226

This is a 1½ volt, 1.05 amp. tube for r. f. and a. f. amplification in circuits designed especially for its use. It is not recommended as a detector and has a

Plate Voltage	90
Negative Grid Bias	6
Plate Current	3.7
Plate Resistance (AC)	9,400
Mutual Conductance	875
Amplification Factor	8.2
Max. Undistorted Output	20
Max. Overall Height	4½"

135	180	Volts
12	13.5	Volts
3	7.5	Milliamperes
10,000	7,000	Ohms
820	1,170	Micromhos
8.2	8.2	Milliwatts
60	160	1½"
Max. Overall Diameter		

DRY CELL TUBES

	CECO		CUNNINGHAM		DUVAL	EXCEL	GEM	JAEGER	PERRYMAN	R. C. A.	
	Types B, BX, C	C-299 CX-299	C-11 CX-12	199	199	199	X-199	JV-199	199	UV-199 UX-199	WD-11 WD-12
Filament Volts	3	3	1.1	3	3	3	3	3	3	3	1.1
Fil. Amps.	.06	.06	.25	.06	.07	.06	.06	.06	.06	.06	.25
Plate V. as Det.	22-45	22-45	22-45	22-45	45	22-45	22-45	22-45	22-45	22-45	22-45
Grid Leak (Megohms)	2-9	2-9	2-9	2-9	2-9	2-9	2-9	2-9	2-9	2-9	2-9
Grid Cond. (Mfd.)	.00025	.00025	.00025	.00025	.00025	.00025	.00025	.00025	.00025	.00025	.00025
Plate Current as Det.	.4	.4	.35	.44	.4	.4	.4	.4	.35
C Volts for 45 V. Plate	1.5	1.5	1.5	1.5	1.5	2.5	2	1.5	1.5	1.5	1.5
Plate Current for Ditto	.7	.7	1.2	.8	1.0	1.8	.7	1.5	.7	1.2	1.2
C Volts for 67½ V. Plate	3	3	3	3	3	2.5	3
Plate Current for Ditto	2.4	2.2	2.3	2.5	2.4	2.0	2.2
C Volts for 90 V. Plate	4½	4½	4½	4½	4½	4½	4½	4½	4½	4½	4½
Plate Current for Ditto	2.8	2.5	2.5	2.6	2.6	3.3	2.8	2.5	2.5	2.5	2.5
Plate Impedance (Ohms)	14,800	15,800	15,000	15,000	15,500	15,500	14,000	14,000	15,600	15,000	15,000
Amplification Constant	6.7	6.25	6.5	6	5.8	6.3	6.5	6.5	6.25	6.5	6.5
Mutual Conductance	450	400	430	400	395	400	410	400	400	430	430

POWER TUBES

	CUNNINGHAM				De-FOREST	R. C. A.				WESTERN ELECTRIC
	CX-112	CX-371	CX-310	CX-220	DV-7	UX-112	UX-171	UX-210	UX-120	205-D
Filament Volts	5	5	8	3	5	5	5	8	3	4.4
Fil. Amps.	.5	.5	1.25	.12	.5	.5	.5	1.25	.12	1.6
Plate Volts	90-157	90-180	250-425	135	135	90-157	90-180	250-425	135	350
C Volts for Min. and Max. Plate Volts	6-10½	16½-40½	18-35	22½	9	6-10½	16½-40½	18-35	22½	30
Plate Current, Min. and Max. Plate Volts	2.5-8	10-20	12-22	6.5	8.0	2.5-8	10-20	12-22	6.5	30
Output Impedance, Min. and Max. Plate Volts	8800-4800	2500-2000	5600-5000	6500	6500	8800-4800	2500-2000	5600-5000	6600	4000
Ampl. Const.	7.9	3.0	7.6	3.3	7	7.9	3.0	7.6	3.3	7
Power Output, Milliwatts Max.	195	700	1540	110	150	195	700	1540	110	1500

HIGH MU TUBES

	CECO	CUNNINGHAM	DAVEN	R. C. A.	SONATRON		SCHICKERLING
	G	CX-340	MU-20	UX-240	MU-20	MU-30	MU-20
Filament Volts	5	5	5	5	5	5	5
Fil. Amps.	.25	.25	.25	.25	.25	.25	.25
Plate Volts	90-180	90-180	90-180	90-180	90-185	90-135	90-200
Plate Current at 90 Volts	1.0	.3	.35	.3	.5	.3	.4
Plate Current at Max. Volts	1.8	.7	.9	1.5	.5	.9
C Volts for Min. and Max. Plate Volts	1-4.5	1-3	.5-1.5	1-3	.5-1.5	.5-1.5	.5-3
Plate Impedance	13,600	60,000	40,000	60,000	24,000	35,000	40,000
Ampl. Const.	20	30	20	30	20	30	20
Mutual Conductance	1420	900*	500	900*	835	900*	500

*At Max. Plate Voltage.

standard X-base. The filament is energized from an a. c. source through a suitable step-down transformer. Its operating characteristics are similar to those of an "A" tube.

UX-280, CX-380 is a full wave rectifier for circuits requiring greater d. c. output than afforded by the UX-213, CX-313, with which it may be used interchangeably.

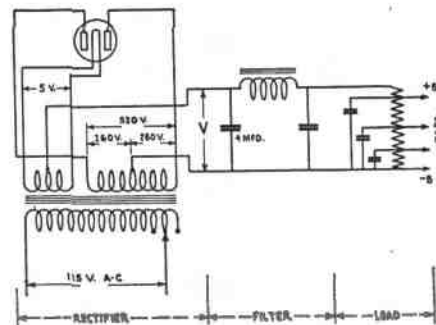

Full Wave Rectifier Circuit for UX-280, CX-380 Tube.

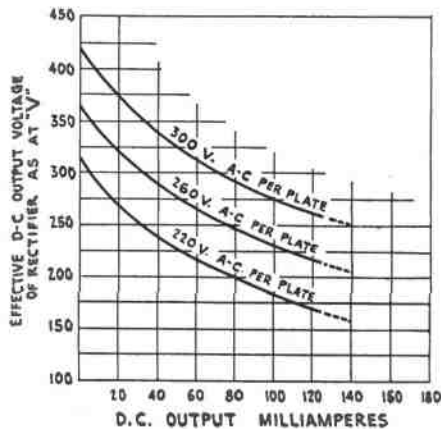

D. C. Output of UX-280, CX-380 for Various R. M. S. Values of A. C. Voltage

FIVE VOLT ALL PURPOSE AND SPECIAL DETECTOR SET

	CECO		CUNNINGHAM		DeFOREST	GEM		JAEGER	KENRAD	MAGNAVOX	PERRYMAN	R. C. A.			
	A	H	CX-301-A C-301-A	CX-300-A	DV-5	201-A	200-A	JX-201-A	KR-0201-A	201-A	150-D	RH-201-A	PD-200-A	UX-201-A UX-201-A	UX-300-A
Filament Volts	5	5	5	5	5	5	5	5	5	5	5	5	5	5	5
Fil. Amps.	.25	.25	.25	.25	.25	.25	.25	.25	.25	.25	.25	.25	.25	.25	.25
Plate V. as Det.	37-45	67-90	22-45	45	45	45	20-45	20-45	22-90	22-45	45	22-45	22-45	45
Grid Leak (Meg.)	2-9	2-9	2-9	2-3	2-9	2	2-9	2-5	2-9	2-9	2-3	2-3	2-9	2-3
Grid Cond. (Mfd.)	.00025	.00025	.00025	.0002500025	.00025	.00025	.00025	.00015	.00015	.00025	.00025	.00025	.00025
Plate Current as Det.	.8	2.6	1.0	1.5	1.0	2.0	1.0	2.3	1.0	1.2	1.0	1.1	1.0	1.5
"C" Volts for 90 V. Plate	4½	4½	4½	4½	4½	4½	4½	4½	4½	4½
Plate Current for Ditto	3.5	2	2.0	2.8	3.1	3.5	2.5	3.5	2
"C" Volts for 135 V. Plate	9	9	9	9	9
Plate Current for Ditto	2.5	3.5	3.8	4.5	2.5
Plate Impedance (Ohms)	6,800	10,500	12,000	30,000	12,000	12,700	35,000	8,000	11,000	8,570	10,500	12,000	30,000
Ampl. Const.	8.5	14.4	8	20	9.5	8	20	7.5	8	8	8	8	20
Mutual Conductance	1210	1250	675	600	800	800	570	900	730	980	780	675	600

An output current of 125 milliamperes may be secured in the circuit shown herewith. Its output current at various voltages is also shown. It has an oxide coated filament of ribbon shape to give ruggedness and long life.

UX-281, CX-381 is a half wave rectifier for circuits requiring greater d. c. output than is possible from the UX-216B, CX-316B, with

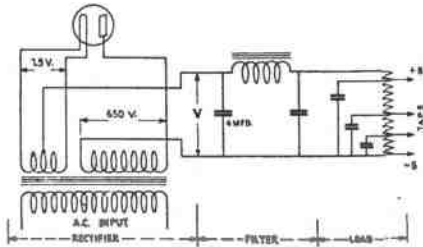

Half Wave Rectifier Circuit for UX-281, CX-381.

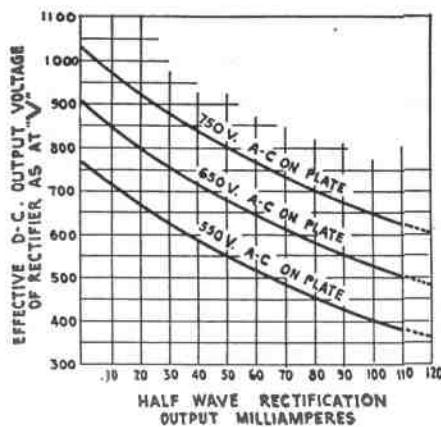

D. C. Output of UX-280, CX-381 Rectifier

which it may be interchanged. In the circuit shown herewith it gives an output of 110 milliamperes. Two of these tubes may also be used in a full wave rectifier.

C-327—UX-327

This is an a. c. heater type in which the electron emission is caused by an internal heating element requiring 1.75 amps. at 2½ volts, a. c. Although it may be used for r. f. and a. f. amplification it is primarily intended as a detector to be used with the CX-326, UX-226. It has a special five prong base. Its characteristics are as follows:

Plate Voltage	90	135	180	Volts
Grid Voltage	6	9	13.5	Volts
Plate Current	3	5	6	Milliamperes
Plate Resistance (AC)	11,300	10,000	9,400	Ohms
Mutual Conductance	725	820	870	Micromhos
Amplification Factor	8.2	8.2	8.2	
Max. Undistorted Output	20	55	140	Milliwatts
Max. Overall Height	4½"	Max. Overall Diameter		1½"

The Quadratron is a four element vacuum tube in which the fourth element, an additional grid, is spaced laterally between the filaments and not interposed between the other elements—plate and grid.

The filament requires .25 amp. at 5 volts. When connected as a three element tube without the fourth element its plate-current grid-voltage characteristic is about the same as that of an "A" tube. By placing from 10 to 30 volts positive potential on the fourth element the plate current is increased from 50 to 100 per cent. This principle may be utilized to stabilize the oscillations caused by the grid-plate capacitance in tuned r. f. circuit, especially in short wave work. It has also been successfully used in a super-regenerative circuit and for a. c. filament operation.

The Emerson Multi-valve contains three separate grids and plates with a single rugged three-section filament. It thus provides a detector and two stages of audio in single tube, and by reflexing the first audio stage may also be used

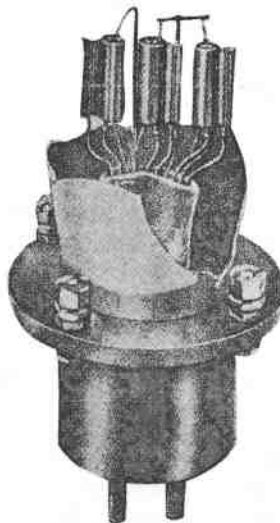

Emerson Multi-Valve

to give one stage of r.f. It is applicable to a large number of circuits. The filament consumption is ¼ ampere at 5 volts and may be used in parallel with any 5 volt tube on the same rheostat. It fits a standard socket, the extra plate and grid connections being made on binding posts in the tube base.

The Sovereign A-C tube is designed to eliminate the filament battery required in most radio receivers, and with the addition of a "B" eliminator for plate supply, permits operating the receiving set

entirely from the electric lighting supply. The tube operates directly from alternating current through a step-down transformer, which reduces the line voltage of 110, to 3 volts, supplying a filament which consumes 1.1 amperes. This filament is placed inside a metal tube which is heated by the filament, and thus becomes an emitter of electrons. The electron emission is practically constant throughout the life of the tube, due to the large surface of the cathode. The tube base is made to fit the standard socket, the grid and plate terminals being the same as for storage battery tubes, and the negative prong being connected to the cathode.



Sovereign A-C Tube.

The a. c. leads to the heater filament are brought out to a pair of terminals on the top of the bulb, so as to be separate from the leads in the base. The plate voltage can be any value from 22 to 160 volts, so that the tube can be used either as a detector, radio or audio frequency amplifier, and can be operated at any commercial frequency from 25 to 60 cycles without change of characteristics. The tube can be used in any type of receiver with but slight modifications in the circuit.

The Van Horn a. c. tube uses a new type of filament requiring 2.5 amperes at 0.8 volts and burning at a dull red heat. This filament has a high electron emission and has been designed to prevent all hum. Due to the greater size of the filament and its low operating temperature the tube life has been found to be at least as long as a standard 5-volt tube. It fits a standard UX socket without other terminals or connections and may be used in an ordinary receiver with slight changes in the circuit.

(Continued on page 85)

"A," "B" and "C" Socket Power Devices

The Mayolian "A" and "B" eliminator combines an efficient 6-volt rectifier and filter with a heavy duty "B" eliminator. The constituent parts are also sold as separate units. These eliminators are made in two types: one to operate a receiver from 110 volt, 60 cycle a. c. and the other from 220 volt, 40 to 50 cycle current. The shipping weight is 54 lbs. The "B" eliminator uses a Raytheon tube and has four terminal voltages, two of which are variable, the maximum being 200 volts. A special type of eliminator with "non-motor-boating" circuit is also provided for receivers using resistance or impedance coupled amplification.

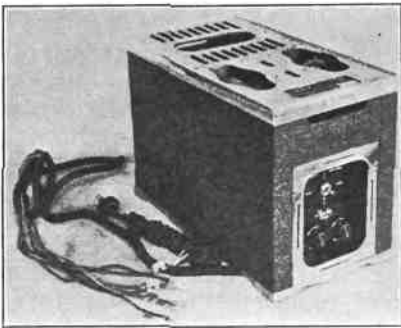

The constituent parts available as separate units or in various combinations include a shielded power transformer with mid-tapped secondary, a heavy duty choke coil, blocks of 1000-volt condensers in capacities from 1 to 5 mfd., and a 2½ or 5 ampere 6 volt charger. A special driver unit is made for sets using a. c. tubes, this supplying low voltage raw a. c. for the filaments and high voltage rectified and filtered a. c. for the plates. The Mayolian Company also makes a "B" supply unit utilizing 110 or 220 volt d. c. supply; this has a dual filter system providing a constant voltage together with a variable control for the detector.

Marco "A" and "BC" socket power units are sold with a year's guarantee that they will render satisfactory service. They are not cheap eliminators of batteries but expensively made devices for supplying d. c. filament current and plate-grid voltages from an alternating current source. The "A" power unit uses Raytheon cartridges with choke coils and condensers. The "BC" unit gives all the needed exact voltages. A storage battery charger using the Raytheon charger is also being made.

The Grebe 671 socket power unit is designed to supply B and C voltages to a five or six tube receiver, including a power tube which requires 180 volts. It is equipped with a cable having colored leads



Grebe "B" and "C" Socket Power Units

for -40, -4, +22, +90 and +180 volts. Its condensers are tested to 1,000 volts d. c. and its resistance units are of the full metallic wire wound variety. Special resistance and condenser circuits are provided to prevent "motor-boating." It uses a BH Raytheon full wave rectifying tube. The unit is enclosed in a hexagonally shaped container having an attractive marble finish.

The Muter "B" power unit is rated at 40 milliamperes for 150 volts and will deliver 180 volts to a 171 power tube used in an eight

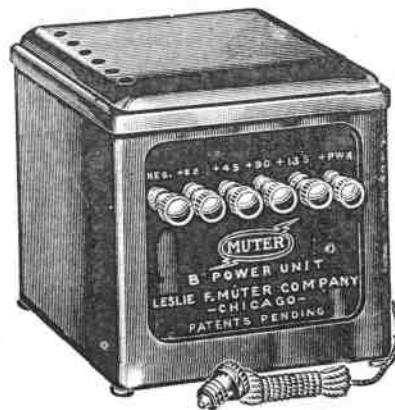

tube set. It uses a UX 213-CX 313 full wave rectifier and Muter filter condensers, transformers and chokes. The resistance unit is wire-wound, with fixed voltage taps designed to give definite voltages.

The Kellogg "B" power unit is designed to supply 40 milliamperes at 180 volts with taps for 45 volt detector and 90 volt amplifier. It uses UX-213 or CX-313 full wave rectifier and operates from 110 volts a.c.

The Basco combination "A" and "B" unit is an exceptionally compact filament and plate socket power supply device for from 1 to 10 five-volt tubes. It is equipped with automatic switch for turning off the A charger as the B voltage is



turned on. Filament current is furnished by a glass-jar Exide battery. This is charged by a 2½ ampere-hour charger using a Raytheon cartridge as a rectifier and a two-winding transformer. The B voltage is supplied by a Raytheon rectifier with a high inductance choke and wire wound resistors. The A and B units as well as the charger are also sold as separate units.

The Burns "B" power unit is rated to deliver 50 milliamperes at 180 volts. It uses a BH 85 Raytheon tube as a rectifier and American Electric transformers, chokes



and condensers. It has one negative and three positive taps with two possible variations on the power tap and variable rheostat on the detector and amplifier tap. Terminals are concealed in accordance with the requirements of the Underwriters Laboratories.

The Atwater Kent "B" power unit, delivers up to 135 volts and is designed for use with any set consuming not more than 40 milliamperes. Operation is automatically controlled by a built-in relay which is actuated by the filament switch on the receiving set. Provision is made for connecting A battery and trickle charger to the Unit, in which case the relay automatically starts and stops the charger. A special rectifying tube made in the Atwater Kent plant is included as part of this equipment.

The Compo "ABC" power unit consists of a 4 or 6 volt trickle charger and storage battery having paste electrolyte and a 180 volt "B" eliminator using a BH85 Raytheon tube as a rectifier. The unit is sold complete with automatic relay switch or separately as "A"

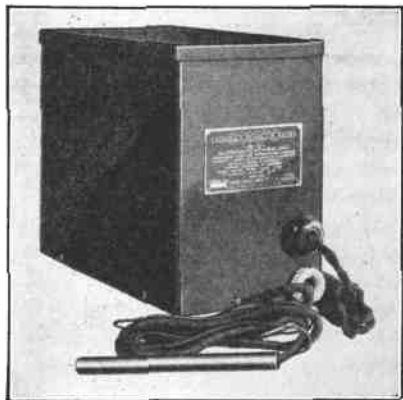

and "BC" units. The charger uses a 2-ampere Tungar bulb and the battery has a 40-ampere hour capacity. The rated output of the plate supply is 50 milliamperes for 22½, 45, 90, 135 and 180 volts. A regulator tube maintains constant voltage on the 90 volt tap. The "C" circuit has two variable controls affording a range of 0-5 and 0-40 volts.

Galvanized steel sash cord makes an excellent pulley rope for high radio poles. This sash cord is a very flexible steel rope of many strands wound over a string core, and comes in many sizes. It is strong, and there is no danger that it will break or rot. The 1/16-in. sash cord is strong enough for receiving aeri- als, even when they are quite large; while the 3/8-in. cord is just right for the more heavy transmitting aeri- als.

Ordinary wall board makes a good heavy backing for a radio map. The wall board backing will keep the map tacks used to indicate the locations of stations from marring the wall. A piece of wall board of the right size can be procured quite cheaply. The map may be glued to it, and then rolled with a photographer's roller or rolling pin to make it smooth.

AUDIO AMPLIFIERS

The newest development in audio frequency amplification is the double impedance system. Several manufacturers have been licensed under the Hiler patents, and an excellent choice of kits and parts will soon be available to the builder.

The Hiler system is somewhat similar to the well known impedance coupling method as is shown in the circuit dia-

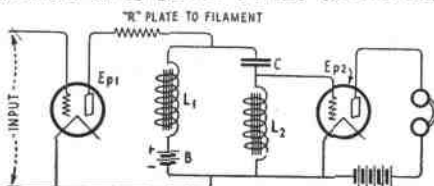

Circuit Diagram of Double Impedance Coupling

gram herewith. It consists of a plate choke coil, L_1 , a grid choke L_2 , and a coupling condenser C , the resistance R in the diagram representing the internal resistance of the tube at the input to the coupler. In the ordinary impedance coupler, the grid leak of from ½ to ¾ megohm limits the power which can be handled without distortion to a relatively small amount. In the Hiler system, the grid choke permits four times the power output of any other system, because there is no magnetic coupling, and the grid of the tube working into the coupler can swing positive as well as negative, thereby preventing tube blocking and rectification.

The values of inductance for both coils, L_1 being 250 henrys and L_2 being 350 henrys, are so proportioned with respect to the coupling condenser that the system is made resonant below the audio frequency range, and hence the amplification is practically uniform over the useful range of audio frequencies from 30 to 6000 cycles.

The Paragon double impedance units may be obtained either in single or triple units, permitting the replacement of individual stages of amplification in old receivers with the new system, or installing a complete three stage amplifier in one unit. The three

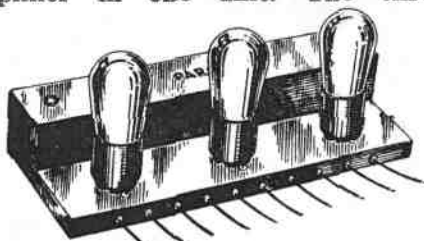

Paragon Triple Double Impedance Unit

stages using the Hiler system give greater amplification than two stages of transformer coupling and can be obtained either completely wired, with tube sockets, or in a shielded metal container with the leads conveniently arranged for connection to separate sockets.

The Ford double impedance unit combines in one case a fixed condenser and two inductance coils. This unit is licensed under the Hiler patent on impedance coupling whereby the grid potential may be made positive without introducing distortion. Thus the power output of an audio tube may



Ford Double Impedance Unit

be four times greater than with transformer coupling where the grid must be kept negative. Each stage has a voltage amplification factor which is much higher than is obtainable with either resistance or single impedance circuits. This unit has four terminals marked P, G, B and F, and is intended for direct replacement of transformer or resistance coupled units. It gives great volume and faithful reproduction of all audio frequencies.

The Centralab Tone Amplifier adds a power stage of audio amplification to any set. It is made in two models, one designed for use with CX-371 or UX-171 tubes operated from a storage battery, and the other using a UX-120 or CX-220

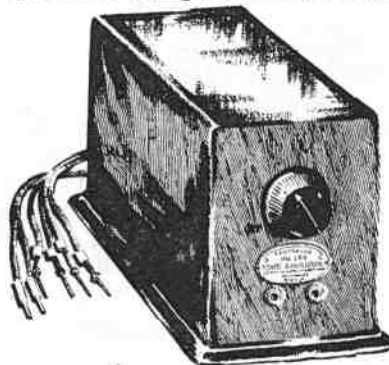

Centralab Tone Amplifier

tube operated from a dry cell. Filament supply and tone volume is controlled by a single knob. It is provided with a tone filter to protect the speaker against excessive "B" voltage and to match the output impedance of the power tube. It is encased in a walnut finished cabinet and may be easily attached without tools.

(Continued on page 90)

Loudspeakers

The Symphonic Globe radio loudspeaker is a library globe whose exterior is an up-to-date map of the world and whose interior is a



Symphonic Globe Radio Loudspeaker

tone-chamber for a loud speaker unit. It is claimed to give remarkable fidelity of reproduction. The globe can be cleaned with a damp cloth.

The new R. C. A. model 104 loudspeaker designed for operation from 110 volts direct current furnishes the necessary "A," "B" and "C" supply for Radiolas 25 and 28 or "B" voltage for practically any other receiver. It uses the same cone

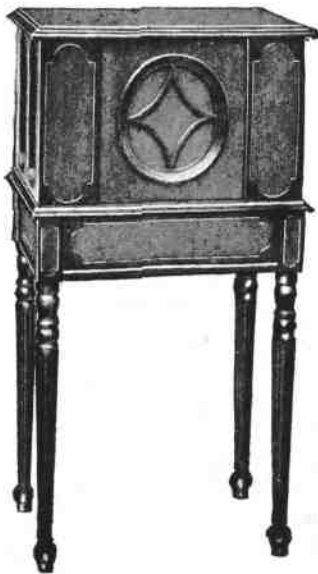

R. C. A. Model 104 Loudspeaker.

and driving mechanism as the a. c. model 104 except that a d. c. power

amplifier has been substituted for the a. c. rectifier power amplifier unit. Four UX-171 tubes are connected in a multiple push-pull circuit to give the same output as the UX-210 tube used in the a. c. model. It has special filters to eliminate line noises and adjustable resistances for utilizing direct current of from 105 to 125 volts. It has the same volume, tone quality and fidelity of reproduction as the a. c. model.



R. C. A. Model 100-A Loudspeaker.

The R. C. A. 100-A loudspeaker, designed to replace the Model 100, has the pleasing appearance of a bronze clock 15 in. long and 11 in. high. It has a newly designed driving mechanism of unusual sensitivity and a 7 in. cone made of specially prepared corrugated paper which prevents rattling and gives faithful reproduction of the entire musical scale.

The Baldwin "99" loud speaker is of the combined cone and horn type with a sensitive Baldwin unit having a balanced armature. It is designed to reproduce low and high notes with their overtones without



Baldwin "99" Loudspeaker

the omission or reduction of the fainter notes and without the introduction of false notes or noises. It is tested to give clean, mellow volume without rattles or blast at the highest amplification. The instrument is finished in dash bronze with a lighter shade of silk in the grill.

The improved Rola Cone is designed to give clear, brilliant tone reproduction under all conditions, irrespective of the make or type of receiving set. It is made in two styles; in one the unit is mounted so as to stand on a table, in the

other it stands on a pedestal, giving the effect of a tilt-top table. Both types are finished in rubbed walnut. Its claim for better articulation over a tone range from 70 to 15,000 cycles is based upon the use

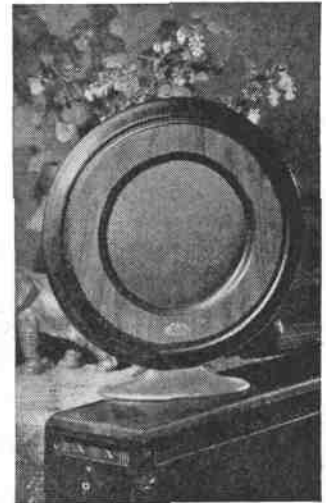

Improved Rola Cone

of a patented laminated armature and of a special cone material that is not affected by changes in moisture and temperature conditions. Although the armature is made up of 28 laminations of silicon steel, it is less than half the size of a postage stamp and hardly thicker than a dime.

Stewart-Warner reproducers employ the new Williamson single armature magnetically balanced unit which is designed to give equal reproduction of all tones from the lowest double-bass to the highest



Stewart-Warner Model 420.



Stewart-Warner Model 425.

piccolo. Model 420 has a drum 9 in. in diameter and 5 in. deep. It gives great volume with minimum power consumption. It is metal finished in bronze golden brown and has silk fabric mesh front and back. Model 425 has a drum diameter of 11¼ in. and width of 6¼ in. Its finish is like that of Model 420 with the addition of a graceful silver silhouette superimposed on the front mesh.

Sonochorde Speakers include four models—two table designs, a wall type and a floor standard type. All are of the perfected cone type. The supporting frame of each model is finished in rich semi-gloss mahogany with base to match and is unbreakable. The cone itself is covered with a wine-colored silk front neatly festooned from the center. Each base is provided with heavy felt pads so as not to mar the finest surfaces.

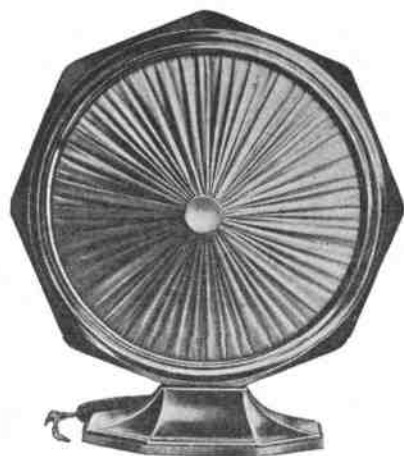

Sonochorde Senior Loud Speaker

The back of each cone is protected with metal arms, thus insuring the reproducing mechanism from possible injury. All models incorporate a balanced armature actuating unit. This unit is ruggedly constructed and utilizes four super-powered magnets, with a minimum air gap. They are claimed to produce exceptional volume, with a rich, deep, sonorous tone wholly natural and free from all distortion. The Sonochorde Junior, Model J-28, stands approximately 15 in. high and is 13 in. in diameter, and like all Sonochordes is provided with an adjustment control. Senior Model A-2 stands 18 in. high with a diameter of 16 in. Wall Model A-C, without the base, is equipped with heavy cord and decorative tassel to meet the vogue for wall hanging. The floor standard design, Model A-S, is mounted on an upright base, similar to a piano lamp.

The **Atwater-Kent Model E speaker** employs a new type of operating unit and a new method of cone suspension designed to respond to the faintest vibrations and to faithfully cover the entire range of musical tones from the lowest to the highest register. The base, casing and grill are of metal, finished in two tones of brown crystalline. It stands 18¼ inches high, is 15 3-4 in. in diameter and 6 in. deep.

The **Grebe 20-20 Cone** is 20 in. in diameter and shaped to a 20 degree angle. It uses a "butterfly"

armature made of laminated silicon steel having a low magnetic saturation and small eddy current

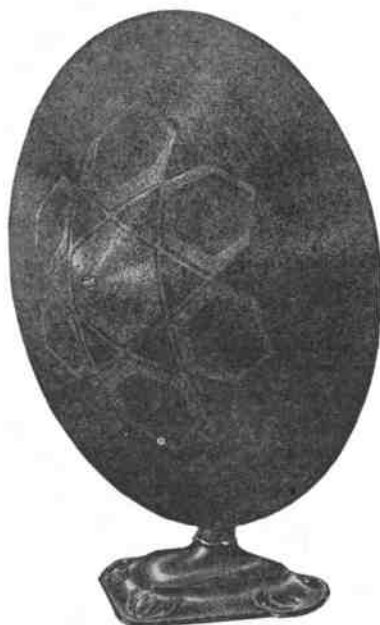

Grebe 20-20 Cone

losses. High and low frequencies are transmitted to the cone with minimum loss by means of short, light-weight driving rods. The manufacturer states that this cone gives a great improvement in tonal reproduction and sensitivity.

The **Thorola new cone speaker**, Model No. 18, combines a wood diaphragm for reproducing the low tones with a paper-cone diaphragm for reproducing the medium and high tones. This two-element diaphragm with the repro-



Thorola New Cone Speaker

ducing unit is protected from injury in the front by a carved walnut grille and in the back by a domed wire screen covered with cloth of gold. It is claimed to give most life-like reproduction of speech and music. The unit is obtainable separately for attachment to a phonograph sound chamber.

The **Peerless cone** has a free edge or floating periphery designed to eliminate dead spots and a double-acting, balanced-armature speaker

unit having no polarity and acting in both directions. It is claimed to have an undistorted tone range



from well below 100 cycles to well above 4000 cycles. The unit is assembled on a steel frame and secured in a mahogany mantel cabinet of Gothic design. It stands 12½ in. high, 11½ in. wide and 7 in. deep.

MISCELLANEOUS

The **Vimco radio light** is intended to illuminate the dials of a radio set, being a portable lamp, with 10



Vimco Radio Light

ft. extension cord, which can be placed on top of the set. It is weighted to prevent tipping. The shade is adjustable and the socket of candelabra size.

The **Dyal Quietron cap** is a slotted metal cover that fits over a 199 type or an A type of vacuum tube.

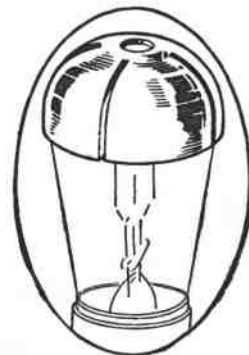

Its purpose is to stop microphonic howls or noises by so weighting the tube that it is not subject to external vibration.

New Parts for the Radio Constructor

H. F. L. Long Wave Transformers

The High Frequency Laboratories of Chicago have developed a line of transformers for the home built receiver, including special types for long wave amplification, as well as for audio frequencies. The long wave transformers are made in two types, the H-210 being an iron core assembly with a high amplification factor between 32,000 and 45,000 cycles, and the H-215 being an air core transformer sharply peaked at 37,000 cycles, at approximately the peak of the iron core coils.

A typical circuit in which these transformers are used is shown in Fig. 1, which is that of a nine tube receiver having an oscillator, frequency changer, four stages of long wave amplification, detector, and two stages of transformer coupled audio amplification. By the use of two air core and three iron core transformers, the total amplification obtainable is extremely large, and yet the selectivity is such that it is claimed that the set may be operated close to a group of powerful local stations without difficulty from interference, when receiving distant stations. The two air core transformers are matched to the same frequency, so that the limit of selectivity is reached, and any sharper tuning of the amplifier results in cutting off the side bands of the modulated carrier wave being received.

The detector tube is operated without grid condenser and leak, the grid being kept sufficiently negative to operate the tube on that part of its grid voltage-plate current characteristic curve where rectification takes place. This tends to stabilize the receiver, and reduces the tendency to oscillate. Volume

control is obtained by varying the filament voltage of the long wave amplifier tubes, and adjustment of the audio amplifier volume is made by varying a high resistance shunt across the secondary of the first audio transformer.

With 27 volts negative grid voltage on the power tube, an output filter will not be required, but if the full allowable plate voltage of 180 is applied to the tube, a filter or output transformer must be used. The long wave transformers are designed for use with the type A tubes, so that type 99 tubes should not be used if the peak frequency of the iron core transformers is to be kept at the same value as the peaks of the air core coils.

R. F. Transformers

The Aero Universal coil is intended for use in any tuned r. f. circuit using up to four stages of r. f. amplification with any type of tube. In many cases it can be

used without shielding as the ratio of coil length to diameter is so proportioned as to minimize its external field. It is 2 in. in diameter and 3 3/8 high. It is ruggedly constructed and has an unusually high ratio of inductance to r. f. resistance. Terminals at its lower end permit short connections either with or without soldering. It is made in sizes to match .0005, .00037, and .00035 condensers for both the higher and lower frequencies of the broadcast band. Because of its low loss construction it gives high voltage gain per stage and sharp selectivity.

The Melocoupler is a radio frequency transformer with air core. It is made in three types, two to amplify the broadcast band of frequencies (Types 120 and 160) and

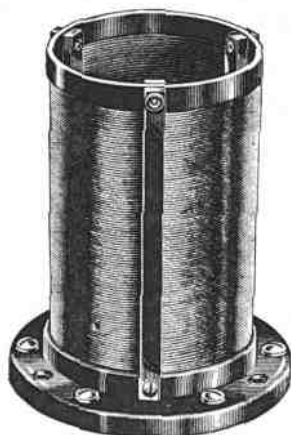

Aero Universal Coil



one sharply tuned to 125 k.c. (Type 135). Type 120 has a low primary impedance and Type 160 a higher primary impedance. These couplers are uniform in size and appearance with the Meloformer which is intended for use in a three stage audio amplifier. These devices are specifically intended for use in the Melo-Heald eleven tube circuit.

(Continued on page 85)

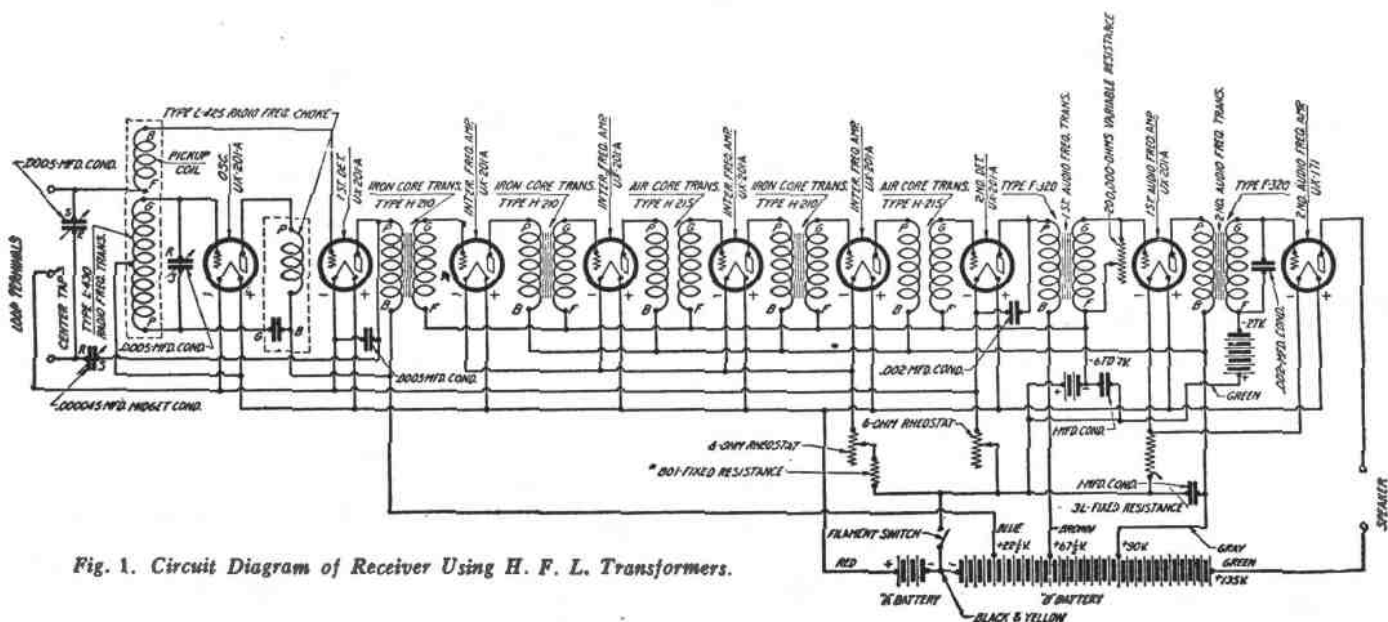
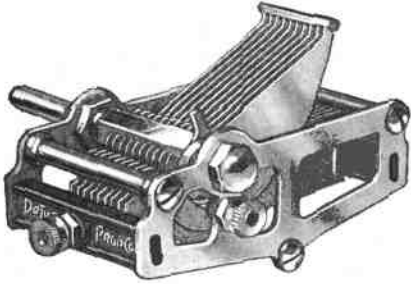

Fig. 1. Circuit Diagram of Receiver Using H. F. L. Transformers.

VARIABLE CONDENSERS

The De Jur straight line variable is a low loss condenser with small phase angle difference and low minimum capacity. The stator plates bear on only one point, being suspended by moulded bakelite outside the electrostatic field. The frame



De-Jur Low-Loss Straight Line Variable Condenser

is grounded to the rotor to eliminate hand capacity. The end tie bar of the rotor plates keeps the spacing uniform. The end plates are of brass, finished in highly polished nickel. A spring phosphor bronze pig-tail makes direct connection from the rotor to the frame. It is made for all standard capacities in single, double and triple types.

The Amsco variable condenser is available in one, two or three gang units, the two gang condenser being shown in the picture. A unique feature of these condensers is the wide spacing between rotor and stator plates, the separation being 40 thousandths of an inch, thus making it easier to match the indi-

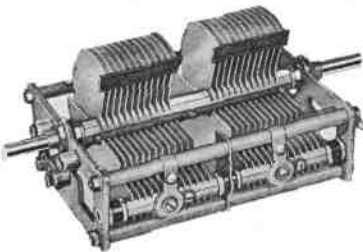

Amsco Variable Condenser

vidual condensers at the factory, and greatly reducing the effect of slight discrepancies in spacing of plates. The triple unit is assembled in a cast aluminium frame, preserving the factory alignment, regardless of the material on which the condenser is mounted. The capacities of the single units which make up the gangs are .00125 and .00035 wfd.

FIXED CONDENSERS

Aerovox filter condenser blocks are supplied in complete and compact assemblies for battery eliminator circuits. The total capacities of the units vary from 8 to 25 mfd. at from 200 to 1000 volts, capacity tolerance being guaranteed within 10 per cent. They are housed in metal cans with mounting lugs and

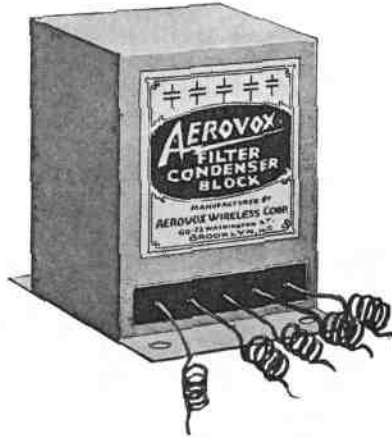

Aerovox Filter Condenser Block

insulated leads. Single units are also made in all the usually required capacities from .1 mfd. up. The foil is stagger-wound to give low loss, long life and minimum heating. Linen paper of the best grade is used as the dielectric, the number of layers being increased as the voltage requirement increases. They are thoroughly impregnated with a non-combustible, non-hygroscopic compound of high melting point.

Aerovox mica condensers are moulded in bakelite to pre-determined standard capacities guaran-



teed within 10 per cent. The plates are of tin foil and the element is thoroughly impregnated. Special lugs allow for screw eyelet or soldering assembly, the soldering lugs having split elongated slots for easy connection to solid or stranded wire. They are made both with and without grid-leak mounting clips.

The Dubilier ABC eliminator block comprises an 8 mfd., a 12 mfd. and two .1 mfd. buffer condensers for use with a Raytheon 350 mill



Dubilier Condenser Block

BA tube. These condensers have a 600 volt d. c. rating which gives sufficient margin to meet excess surges that might otherwise shorten their life. These meet all the requirements for an A, B and C socket power device.

DIALS

The "Glo-Dial" vernier has a transparent scale illuminated from the rear by a 6 volt 1/10 ampere lamp run from the "A" battery and controlled by a small switch. Operation of any standard type of condenser is controlled by a small knob



Glo-Dial Vernier

which projects through the front panel as does likewise the panel window. The rest of the device is easily mounted back of the panel. There is no "back-lash" or "play" as tuning is made possible by the use of a smooth, positive, friction drive.

VARIABLE RESISTANCES

The Electrad "Tonatrol" is designed as an efficient rheostat for controlling the tone and volume of

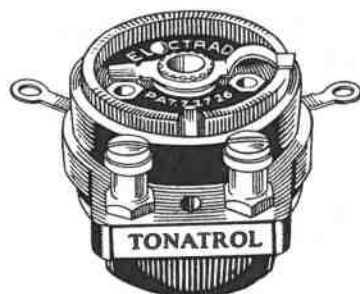

Electrad Tonatrol

a set. It is neat and compact in appearance and has a bakelite knob to harmonize with the panel. It is available either with or without a filament switch.

The Centralab Modu-Plug is a variable shunt resistance mounted on a phone plug. It is used to con-

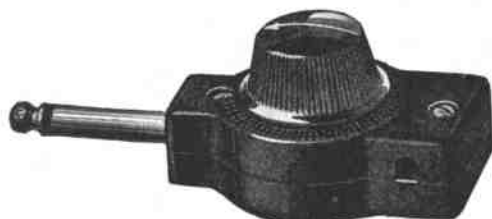

Centralab Modu-Plug

trol loud speaker volume and prevents distortion caused by overloading the speaker.

The Mountford Tapohm is a tapped wire wound resistance designed for use in "B" eliminators to regulate the detector tube voltage. When a Kroblak resistor of 25,000 ohms is connected in series

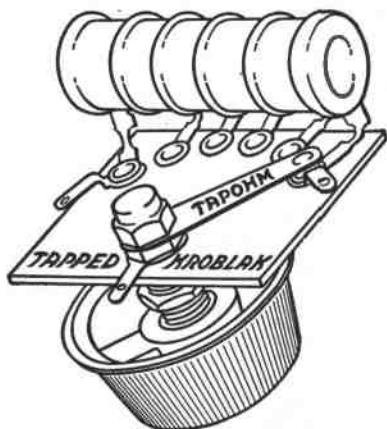

Mountford Tapohm

with the Tapohm and the voltage from the rectifier is 135, then the range covered by the Tapohm will be as follow: 0-14-15-24-27-33-41-45-48 volts approximately. If the rectifier voltage is 185 the range will be: 0-20-22-33-36-43-47-52-57 volts approximately. Wherever the rectifier voltage exceeds 200 volts, the Kroblak used in series should be

50,000 ohms instead of 25,000. By using two Tapohms both detector and intermediate voltages can be regulated. In fact Tapohm can be used wherever a good variable resistor is needed in any "B" eliminator.

The Centralab Power Rheostat is designed for use in the new Raytheon and QRS battery eliminator circuits where currents of 250 milliamperes must be handled with a dissipation of power up to 50 watts. By mounting the resistance

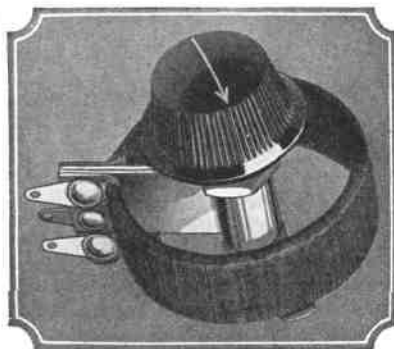

wire on a heat resisting support, with ventilation on all sides of the resistance, the rheostat has been made in a very compact size, for back panel mounting. It comes in 150, 250 and 500 ohm sizes, the first two being provided with three terminals, so that they may be used as potentiometers.

The Amsco Monostat and Duo-stat are, respectively, a single-arm and double-arm potentiometer designed to give the correct "C" bias to amplifying tubes. The units are wound with a special alloy wire

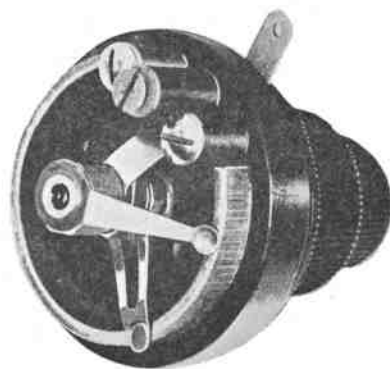

having a total resistance of 2,000 ohms and passing 65 milliamperes without undue heating. The Duo-stat gives two variable "C" potentials and the Monostat one. Both types may be mounted in the space required for a single rheostat.

The Frost combination is a variable high resistance and a filament switch in one unit. It is made in a two terminal and in a three terminal type, each of which is avail-

able in seven sizes with maximum resistances of from 2000 to 500,000 ohms. The switch-operating cam opens the filament circuit when the

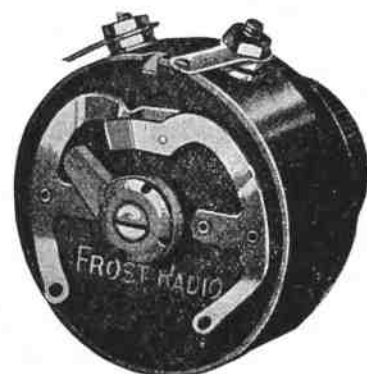

Frost Combination

knob is completely turned to the left and locks firmly in the "off" position. The switch assembly is mounted on bakelite. A similar set of units are also made without the switch.

FIXED RESISTORS

Aerovox "Pyrohm" resistances are made of the best grade of resistance wire, wound on a refractory tube, and coated with a porcelain enamel which thoroughly covers and protects the wire from moisture, oxidation and mechanical injury. The wire, tube, and enamel have the same coefficient of expansion, which allows the unit to be used under heavy loads without displacement or injury to the wire.



Aerovox Pyrohm

In the process of manufacture, the unit is subjected to high temperature; and for this reason will stand overheating in service without injury. Heat is radiated rapidly from the glassy porcelain surface. The resistance value is permanent and will not change with use. Pyrohm resistances 2 in. long will dissipate 20 watts; the 4 in. type, 40 watts; and the 6 in. length will dissipate 100 watts. Manufactured in all usual values from 500 to 50,000 ohms, with intermediate taps if demanded.

The Frost fixed resistances are furnished in 23 standard sizes having a resistance in ohms of .4, .5, .6, .7, .8, 1, 1.3, 2, 4, 5, 6, 8, 10, 20, 25, 30, 40, 50, 100, 200, 400, 600, or

1000 respectively. The resistance element is wound on flexible bakelite so as not to be affected by moisture or changes in temperature.



FROST RADIO

Ample current carrying capacity is furnished by large wire and wide heavy strip. The copper terminal brackets are securely fastened and are tinned for easy soldering.

The Amsco Metaloid power resistors are made with the usual values from 250 ohms to 10 megohms, tapped or untapped. They are rated from 1 to 60 watts for baseboard and panel mountings, also at 2 and 5 watts for plug-in

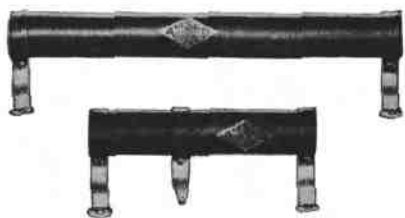

Amsco Metaloid Resistors

mounting. The resistor element is formed to an Isolatite base. These units have a slight negative temperature coefficient so that the drop in resistance as the current increases tends to counteract the augmented drop in the rectifier with which it is used. This gives a more constant output voltage at different loads.

Elmenco Hy-Watt resistors are made for battery elimination circuits employing Raytheon tubes and other means of rectification requiring high current loads without change. They are non-inductive



Hy-Watt Heavy Duty Resistor

and non-arcing and designed to carry 12 watts continuously. The ohmage of the nine stock sizes varies from 100 to 100,000 ohms. With good air circulation and vertical mounting a power dissipation of 25 watts per square inch is possible.

VOLTMETERS

The Weston battery eliminator voltmeter is a special form of the Model 489 double range d.c. voltmeter made with a resistance of 1,000 ohms per volt. For full scale deflection the total current consumption of the voltmeter is 0.0001



ampere, which is not sufficient to cause an appreciable drop in the voltage supplied by the eliminator. This new instrument may be had in double-range combinations of either 0-50 and 0-250 or 0-8 and 0-200 volts. A multiplier for increasing the range of the former to 500 volts may also be obtained. Each instrument is supplied with pin-jacks for panel mounting and with a pair of 30 in. flexible cables having pin terminals at one end and forked terminals at the other.

The Weston radio set tester is designed to measure the continuity of the circuits or the various voltages used in a radio set either at the battery terminals or in the tube sockets. UX-plugs and sockets are provided for the latter use.



The instrument consists essentially of a 0-20 milliammeter with resistance units enabling measurements of 0-8, 0-80, and 0-200 volts. These units have a resistance of 1,000 ohms per volt so that the tester is suitable for measuring the output of battery substitutes as well as of batteries. It may also be used to measure the plate current of tubes.

The Weston pin-jack voltmeter is intended for panel mounting and is used measuring filament voltage. It is made in two models with ranges of 5 or 7 volts. It has a resistance of 125 ohms per volt, which gives a current drain of 5



milliamperes at 2/3 scale (the average operating condition). The instrument may be removed from the panel and plugged into a separate high range stand so as to give readings up to 200 volts in measuring battery output.

The Hoyt "Table Type" voltmeter is designed for testing the output side of a socket power device in determining the actual plate voltages supplied to a set. It has



an internal resistance of 1000 ohms per volt which means a current consumption of .001 amperes by the meter. It has two ranges: 0 to 100 and 0-500 volts. Its scale is large and legible.

Westinghouse PX-3 and PX-4 voltmeters are laboratory models that have been adapted to meet the exacting needs of "B" eliminator testing. They have a resistance of



Westinghouse PX-3, PX-4 Voltmeter

750 and 1000 ohms per volt respectively and are accurate within 0.5 per cent. The scales are unusually long and are designed for easy reading with red lines at the values used for "B" voltages.



QUERIES *and* REPLIES



Questions of general interest are published in this department. Questions should be brief, typewritten, or in ink, written on one side of the paper, and should state whether the answer is to be published or personally acknowledged. Where personal answer is desired, a fee of 25c per question, including diagrams, should be sent. If questions require special work, or diagrams, particularly those of factory-built receivers, an extra charge will be made, and correspondents will be notified of the amount of this charge before answer is made.

Have a five tube tuned r.f. set with jacks for phones and loud speaker. The loud speaker jack no longer works, although tubes and batteries test O.K. What can I do to make the set operate the loud speaker?—L. G., Norwich, Conn.

The insulation of the output jack has probably broken down and the loud speaker is thus shorted out. If the jack cannot be easily replaced or repaired, connect the loud speaker terminals between the P terminal of the last audio tube socket, and the positive of the B battery, first disconnecting the wires leading to the jack.

Where can I get full information on the Loftin-White circuit?—G. W. K., Hope, N. D.

Write to the Loftin-White Laboratories, 1 Union Square, New York City.

Which gives the greatest volume with a given receiver; a long or a short antenna? Is a cage antenna better than a single wire?—M. M. McL., La Panza, Calif.

Within limits, a longer antenna will give a greater signal strength, provided the tuned circuits associated with it are of the right design. Usually a long antenna will require a more selective receiver, due to the tendency of the antenna to pick up interference. A cage antenna is normally used in transmitting on commercial wave lengths above 200 meters, and is little better than a single wire for broadcast reception.

Have a set of Branston intermediate transformers to use in the Best Superheterodyne. Can these be used with 301-A tubes, and have you an improved diagram for an 8 tube model in which these could be used?—F. C., Williams-ville, N. Y.

The transformers you have can be used without difficulty in the Best Superheterodyne. A suitable diagram for an 8 tube model, using a stage of tuned r.f., 2 intermediate stages, detector and two

audio stages, with 171 power tube, is shown in Fig. 1. With 3 stages of intermediate amplification, there will be difficulty in keeping the amplifier free from oscillation, and since a considerable gain can be had with the tuned r.f. stage, the arrangement shown in Fig. 1 is preferable. Use the apparatus layout as described for the 1927 Best Super in the February issue of RADIO. A reprint of this article will be sent if the February issue is not available, upon receipt of a stamped, self addressed envelope. In order to obtain a small amount of regeneration, in the 1st detector circuit, and thereby stabilize this tube to a certain extent, the r.f. transformer secondary should have a split winding, such as is had with the Silver Marshall type 110-A coil. If the link motion is used, as in the February article, the two links should be cut with a hack saw, and a piece of each link removed so that a short strip of insulating material, such as 1/8 in. bakelite, can be inserted, to prevent the short circuiting of the two shafts of the antenna and r.f. transformer secondary condensers. If separate tuning condensers for each coil are used, making it a three dial set, the link motion will not be needed.

Have read the article on the Electric Phonograph in February RADIO, and wish to know if this amplifier could be used as the audio amplifier of an 8 tube Superheterodyne, so that by throwing a switch, the amplifier could be used either for the radio set, or the phonograph.—V. H., Oklahoma City, Okla.

The amplifier is ideal for any radio set, as it operates entirely without batteries. It can be used as B battery supply for the receiving set by taking off suitable taps from the output of the filter, in the power plant associated with the amplifier.

Would like to know if it is possible to construct a miniature telephone re-

ceiver, to fit in the ear in connection with a deaf-phone.—T. R., Tacoma, Wash.

This type of receiver is extremely delicate, and so far as we know, the only firm manufacturing such a device is the Western Electric Company, who make a complete deaf-phone using a vacuum tube amplifier and miniature receiver.

Is it possible to still obtain a panel and baseboard layout of the 1925 model Best Superheterodyne?—M. G. B., Columbus, O.

We still have a few reprints of this article on hand, which include the panel and baseboard layout. The price is 25 cents.

Have built the socket power receiver described in August, 1926, RADIO, and notice a distinct hum which is audible both with the loud speaker connected, and when it is removed from the circuit. What could be causing the noise?—J. L. S., Oakland, Calif.

Undoubtedly you have a power transformer with loose laminations of the core. Take the transformer back to the dealer from whom you purchased it, and he will be glad to send it back to the factory for replacement.

Am interested in the Infradyne Adaptor for the HiQ receiver, as described in February RADIO. Will I require any parts not listed in the data on the Adaptor? Should the Adaptor be separate from the HiQ? What additional range can I expect to obtain?—D. R. F., Niagara Falls, N. Y.

There are no additional parts required, as everything necessary to build the adaptor is given in the parts list. The easiest method of converting your HiQ set into an Infradyne is to build the adaptor separately, and either mount it in a cabinet, on top of the present receiver, or place it alongside. You will probably increase the present range of your set at least 50 per cent.

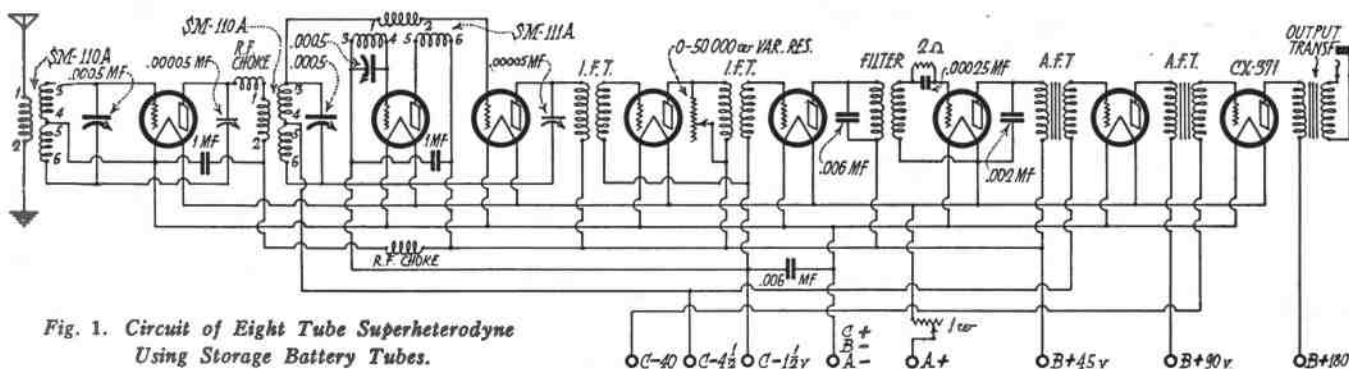
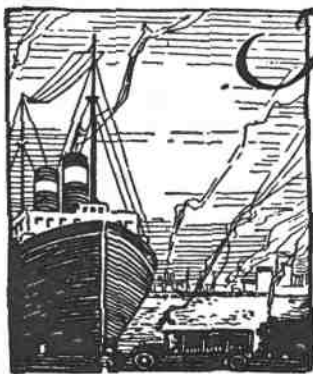

Fig. 1. Circuit of Eight Tube Superheterodyne Using Storage Battery Tubes.



R. O. KOCH, Great Lakes Correspondent

The COMMERCIAL BRASSPOUNDER

A Department for the Operator at Sea and Ashore



Edited by P. S. LUCAS



C. WILLIAM RADOS, Boston Correspondent

BEAMING ACROSS THE ATLANTIC

Well, the man who is responsible for our twitching fingers has scored again. Since Marconi gave up his experimental work for the more enhancing sport of politics we haven't heard much about him, except an occasional report that he was soon hoping to be QSO Mars, or that he was attempting to shoot his high frequency oscillations in a straight line, or some such "high-fallutin'" stunt. Now comes news that this dream of directional transmission has become a reality, and a practical one. And that communication engineers are convinced of its feasibility is proven by the fact that Great Britain has adopted the idea and put it to work. Canada is already linked up with her mother country as the first link in the chain of wireless stations that will place Great Britain, Canada, Australia, South Africa and India in instantaneous communication with each other.

As is well known, conservative England is not prone to squander her resources on filmy, unproven theories, especially at this time when she is still trying to effect a financial recovery from the costly world war. Therefore, when the postmaster told the Marconi Company to go ahead with this elaborate and expensive system of communication, he, and those for whom he speaks, must have had a lot of confidence in beam transmission.

This latest development of Marconi's is elaborate. It is quite different from the little spark with which this gentleman first worked across the Atlantic. And upon the success of the first test, which must provide continuous operation for at least 18 hours, at a speed of 100 words per minute, hangs the realization of the hope and dream of Marconi and his staff since that first trans-Atlantic QSO in 1901.

The important principle of the invention is, of course, the antenna reflecting system. Five steel masts are used, each being 300 ft. high and with a 90 ft. crossbeam. The antenna wires (each set having a specially wound inductance) are suspended from one end of this beam, while the other end holds the reflector wires. The striking feature of the system is that, in concentrating into an angle of 15 degrees the energy that would ordinarily be distributed throughout the 360 degrees, the distant receiving point which lies within the arc of that angle receives the signals 24 times more strongly than under the broadcasting system. Thus, all other things being equal, a 10 k.w. station projecting its radiation in a narrow 15 degree beam becomes, so far as the distant receiver is concerned, the equivalent of a 240 k.w. station radiating in all directions.

The beam system even does better than this, for by employing a similar reflector system at the receiving station the energy from a large area of the advancing wave front can be drawn from and concentrated on the receiver, so that the total energy increase, with a 15 degree reflector at either end, provides for a multiplication by about 576 times the energy that would be received in the ordinary way. But we'd better stop figuring before we blow out our detector tube.

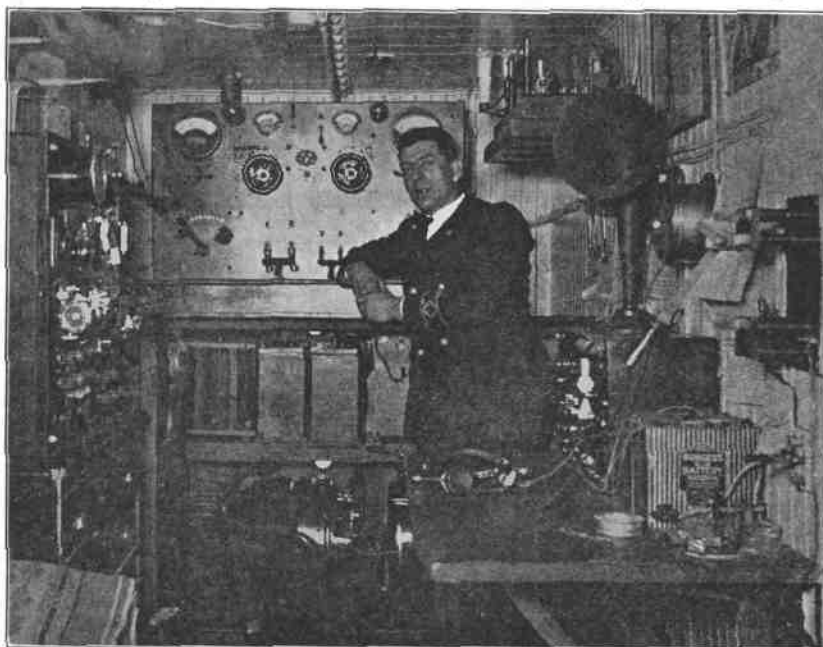

A Typical Canadian Radio Room

It stands to reason that with such a wallop at the receiving end, the only limitations to the speed with which traffic may be handled are those of the automatic keys themselves. If you want some practice just watch the charts for the time your ship crosses the line between Drummondville, P. Q., Canada and Bridgewater, in Somerset, England, or between Bodwin Moor in the County of Cornwall, England and Yamachiche, Canada. You'll get your practice. The waves used are: 60 meters at night and 26 meters during daylight. If anyone ever tunes in on one of these stations we should appreciate a report.

Before signing off,—how long will it be before ship operators go after their land stations with a steering gear?

WEATHER NOTE

By CARL ZINT, KNT

Station VMG, in Apia, Samoa, sends out an excellent weather report for the South Pacific Ocean twice daily. The station is spark equipped with a 500-cycle note, operates on 2000 meters and, static permitting, can be copied up to 1200 miles daylight and up to 2000 at night easily on the average ship receiver. Owing to usual static conditions everything is sent QSZ.

Daily report is at 12:30 a. m. Pacific time and again at 3:30 p. m. The weather report consists of the name of the place the report is from, barometer reading, temperature, dry and wet bulb thermometers respectively, wind direction and force in Beaufort Scale, and state of sky and weather in Beaufort notation, and time at which observation was taken. The reports are from the following places except when under heavy QRN conditions they cannot get them through. Apia, Suva, Papeete,

Nukualofa, Rarotonga, Vila, Numea, Vavau, Norfolk Island and Awanui, N. Z.

TYPICAL CANADIAN SHIP INSTALLATION

By C. W. RADOS

At the right on the operating table can be seen two keys, the receiving equipment, and the change over switches. A long, single blade changes from transmitting to receiving. On the table is mounted a Kennedy, intermediate wave receiver, with a two-stage amplifier.

Just in back of the table, on the other side of the room, are the emergency transmitter and the battery panels. A ¼ k.w. rotary gap transmitter puts about 1½ amperes into the antenna. Communication up to distances of 150 miles has been established. A motor driven interrupter is used. The battery panel is a companion panel carrying the usual switches, meters, and rheostats for regulating the A and B batteries and also the 24-volt emergency battery which runs either of the small transmitters.

Taking up the whole rear end of the cabin is the 2 k.w. synchronous spark. This machine is the cabinet type which encloses the motor generator, gap, and inductances in a thickly muffled "refrigerator" box. When the doors are closed hardly a sound can be heard from the gap. The gap, power condenser, helices, and motor generator can be seen. Just above the cabinet is the switchboard carrying the hand starter, switches, power and radiation meters. The rheostats regulate speed and voltage.

In the upper right, over the operator's head, is a 10 in. spark coil using a straight gap. This is supposed to squawk 100 miles when connected.

MAKING FRIENDS WITH THE ARC

By RAWSON B. DIXSON

There still seems to be a large number of experienced operators who have never handled arc transmitters, or who have been unable to get satisfactory results with arcs, and radio service companies do not like to place an operator without arc experience on an arc-equipped ship.

But there is no reason why the experienced spark operator should not make good on his first trip with an arc. A little attention and intelligent handling, and the trick is done.

First of all, it is absolutely necessary to have good antenna insulation. Porcelain and pyrex are best. After electrose has been exposed to the weather for a while its surface becomes porous and will retain moisture and it will break down in wet, or even foggy weather.

Next, it is essential that the arc chamber be air-tight. There are several places an arc chamber can leak, but most frequently it is around the top. See that the chamber gasket is in good condition. If not, replace it with a new one. Thoroughly clean both the upper and lower surfaces of the chamber where the gasket fits, scraping away all grease or dirt with a knife. Then give the underside of the gasket a coat of vaseline and press it in place on the lower part of the chamber. Be careful not to get any of the vaseline on the upper side of the gasket. If you do, the gasket is liable to be pulled out of place by the upper part of the chamber when the arc explodes.

Sometimes the hinge-butt on the arc chamber becomes bent down, due to being struck by the locking pin during heavy explosions. In some cases the hinge-butt is bent so far that it will not allow the top of the chamber to seat in front. The remedy is to remove the hinge-pin and grind it down until it can be slipped in place when the arc is closed.

Next, look to the pressure regulator. The diaphragm is of soft rubber, which should be replaced when the rubber goes "dead." If you cannot get the same material used by the manufacturer, get a piece of thin sheet rubber packing from the engine department and cut a new diaphragm. Some operators use a cardboard diaphragm with a pinhole in the center. This will work, but is apt to be torn by an explosion.

If you want to avoid explosions entirely, open the small door in the side of the arc chamber before striking the arc, closing the door after the arc has been struck. Most operators keep this door sealed with shellac or paint, to prevent a possible source of leakage.

After good insulation and a tight arc chamber, a straight carbon and plenty of alcohol come next in importance. Saw off old carbons with a hacksaw and true them up with an old file. Better yet, get a brass tube about 2 in. long, just big enough to slip over the carbon. Saw two slots in the end of the tube and solder into them a small blade made from an old hacksaw. After the carbon has been sawed off, place it in the tube, give it a few twists, and the carbon will be trued up. The main point is to have the carbon even. The space between the anode and cathode is very small, so if the carbon is not even there will be a relatively big variation in the length of the arc as the carbon revolves, with a resultant unsteady note.

Then be sure the arc gets enough alcohol. The carbon should build up evenly in the shape of a bevel gear. If the carbon burns to a point, not enough alcohol is being fed into the chamber. As soon as a carbon begins to get lopsided, replace it.

It is a good plan to have a new carbon handy in the spare carbon holder, so carbons can be changed in an instant. Bore a hole about 1½ in. in diameter, through the table, near the arc chamber. Drop the spare carbon holder into this hole, with the handle pro-

jecting above the table. It will then be handy for you to change carbons in a jiffy.

An ignition key will be found a great convenience in striking the arc, even though it is not used for signalling. But very good results can be had in signalling by use of the ignition key, if the operator will take the trouble to look after it. The ignition key cathode is of soft copper and becomes bent and battered with use, and must be frequently straightened. Adjust the length of the stroke until it is just long enough to ignite the main arc. Then adjust the position of the plunger in the solenoid so it will respond readily to the hand key.

If the arc is equipped with a back-shunt key, adjust the middle electrode of the key so it will make contact with one outer electrode just before it breaks contact with the other. Best results require a nice adjustment, which, however, is not hard to make.

The use of the ignition or back-shunt key is especially desirable when using the chopper, as it eliminates the usual "static" and back-wash of other keying circuits. I have found it a good plan, in using the chopper, to keep the copper flour brushes ground to an edge. A clearer note seems to result. A power tube rheostat in series with the chopper motor will allow a variation of motor speed, with a consequent variation of note.

Keep the chopper commutator clean with No. 000 sandpaper. Wrap the sandpaper around a smooth block of wood, so it will cut the commutator evenly. Keep the arc clean, and keep all moving parts lubricated.

Owing to the heat, oil or grease will gum on that part of the carbon rotating mechanism that projects inside the chamber. When this happens take the parts out and clean them. It might be a good plan to add a little flake graphite to the oil, where it is exposed to the heat of the arc.

Keep the pump gland lubricated with Albany grease. The gland packing is wire-woven, and if the gland is not kept lubricated the wire in the packing will wear grooves in the pump shaft, causing the gland to leak and perhaps requiring a new pump shaft.

If, for any reason, you have to remove the pump motor from its base, be careful to keep the shims under the feet of the motor in their original places. If you get them mixed up it will be a tedious job to again line up the motor. If it is not properly lined up, the motor will sound like a concrete mixer and will soon wear out its bearings.

Change the water in the cooling tank occasionally, flushing out the cooling system with clean water before refilling the tank. It is a good plan to take the cooling system connections apart once in a while and swab them out with a rag on the end of a wire. It may surprise you to find how much debris has collected to retard the free flow of water.

In writing this, I have had in mind the 2 k.w. arc, but much of what I have said will also apply to the 5 k.w. However, the 5 k.w. equipped ships are usually passenger ships, so there will be at least one experienced arc man aboard.

On 600 and 800 meters, the arc is not at its best, but from 1800 to 3000 meters it steps out and gives you your money's worth. So, when you're shipmates with an arc, don't immediately decide it's a rock-crusher and an obsolete bunch of junk. Study its peculiarities, handle it intelligently, and you'll be able to snow the spark boys under, when it comes to distance.

MORE ABOUT REGS

By PAUL OTTO, WKN

Mr. Dixon's article on Radio Laws certainly is good, and although it seems sort of hopeless to expect better conditions in the professional operator's game in the immediate future, there is nothing like trying for them. The old saying is: "Nothing ventured, nothing won." I have a few additions to submit to Mr. Dixon's

list which I think will do a great deal to help clear up the present condition.

1st—Paragraph 146, Part III: Should read: An operator's license, other than commercial, etc. . . . Then insert the following paragraph. A commercial operator's license may be granted to any male person, a citizen of the United States, and twenty-one (21) years of age or over who can fulfill the requirements for the class of license desired.

2nd—Add to Paragraph 76, Part II: Testing of ship stations at sea should be conducted between the hour of 7:00 a. m. and 7:30 a. m. local time, and is prohibited at all other hours except in case of a breakdown. Penalty for violation of this provision will be suspension of operator's license for three months for first offense. The second offense shall be deemed malicious interference and prosecuted under the act of August 13, 1912, section 5. (And this should be strictly enforced.)

3rd—An article should be provided for the exchange of position reports, etc., from ship to ship: The exchange of position reports, and all other unimportant ship to ship business should be suspended between the hours of 5:30 p. m. to 7:30 p. m. local time.

During these hours the air is unusually heavy with ship to shore traffic and to my observation 99 per cent of the jamming is caused by the exchange of position reports from ship to ship, which could be done with less trouble all around outside of these hours.

THE FLIVVER GOES TO SEA

By NESTOR BARRETT

The following received from Operator L. F. Carlton of the U. S. Light House Tanker Kukui, Hawaiian Island (WWDX), should be of interest to all sea-going "ops."

"Because of an economical chief engineer not believing in radio, the ship's dynamo is in operation only from 6:00 p. m. to 10:00 p. m. while the ship is at anchor or not actually under way at night. This makes it hard for the radio operator, there being no emergency batteries on this Packard. When I receive a call during the daytime, it takes from eight to ten minutes to get juice to answer. By this time the ship or coastal station that called me is off watch or QRW with someone else. I've actually had as much as ten hours delay on traffic within 200 miles of NPM. I've put up with this for the last sixteen months, so this trip I decided to fix things up right.

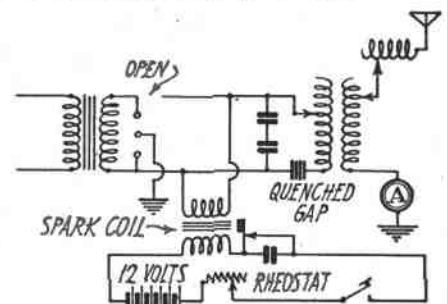

Emergency Spark Coil Connection to Transmitter.

"I took a Ford spark coil, connected my two 6 volt A batteries across the primary in series with a variable resistance and connected the output to the radio frequency circuit of the 1 k.w. Kilbourne-Clarke standard navy transmitter, using one well seasoned quenched gap and very loose coupling between the primary and secondary of the oscillation transformer. (See accompanying diagram.)

"The result was a 240 cycle note, well within the law of decrement. Owing to the small aerial, my antenna current is almost twice the value on 600 than on 952 meters. I worked NPM, 190 miles, during daylight through heavy QRN on 952 meters. He reported signals very QSA. This is as far as I've had occasion to use it to date."

With the Amateur Operators

A 100-Watt Tuned Grid and Plate Transmitter, By G. M. Best

IN THE MAY, 1927, issue of RADIO a 15 watt tuned grid-plate transmitter was described as the first of a series of transmitters ranging in power from 15 to 1,000 watts. These transmitters are of unit construction and have been put together with sufficient care in design so that their appearance as well as excellent operating characteristics are beyond reproach. They were designed by Ralph M. Heintz, 6XBB and 6GK.

The transmitter herein described employs two 50 watt UV-203-A or similar transmitting tubes in a self rectifying circuit, and using the 60 cycle supply for both filament and plate voltage. The UX-852 transmitting tubes can also be used in this circuit by a suitable increase in the transformer secondary voltage.

A circuit diagram is shown in Fig. 1 and is similar in principle to the circuit for the 7½ watt "Bumblebee" previously described. The 2 tubes have their filaments placed in parallel across the secondary of a filament transformer

- LIST OF PARTS**
- 2 Hammarlund transmitting condensers .00045 mfd.
 - 1 Hammarlund transmitting condenser .0002 mfd. Antenna series.
 - 2 50 watt type tube sockets.
 - 2 UC-1846 Faradon condensers .000037 mfd. each. 2 in each unit.
 - 2 Dubilier .004 mfd. filament bypass condensers.
 - 2 10,000 ohm Ward Leonard grid leaks.
 - 1 Jewell A. C. voltmeter 0-15 v.
 - 1 Jewell A. C. ammeter 0-10 a.
 - 2 Jewell thermocouple ammeters 0-5 a.
 - 2 Condenser panels 4x6x¼ in.
 - 1 Tube socket shelf 6x8x¼ in.
 - 1 Antenna tuner panel 5x22x¼ in.
 - 1 Power panel 6x21x¼ in.
 - 4 R. F. chokes—see text.
 - 1 Thordarson type T121 filament transformer.
 - 1 Thordarson type T126 plate transformer.
 - 2 Control switches for fl. & plate—G. E. 10-A toggle.
 - 1 Allen Bradley primary rheostat, type 210.
 - 1 Autotransformer.
 - 1 Wooden chassis, 8x16x¼ in. — ½ in. stock.
 - 1 Cabinet for power panel, 10x20x12 in. inside.
 - 2 1x¼x21 in. brass channels for chassis.
 - 1 Rack and pinion.
 - 2 Strips ½x¼ in. brass, 18 in. long, for antenna panel supports.
 - 1 Tap switch for autotransformer taps.
 - 1 Set inductance coils—see text.

sions of the various supporting panels together with the size of the cabinet.

The antenna-counterpoise panel is supported by brass brackets at each end, each bracket being made from a pair of ¼ by ¼ in. brass strips 19 in. long. The method of assembly is clearly indicated in the picture. The grid r.f. chokes are of the untuned type and consist of 175 turns of No. 28 silk covered wire wound on a 1 in. wooden rod 3½ in. long. The plate chokes are identical except that they have a short circuiting ring made of ¼

(Continued on page 70)

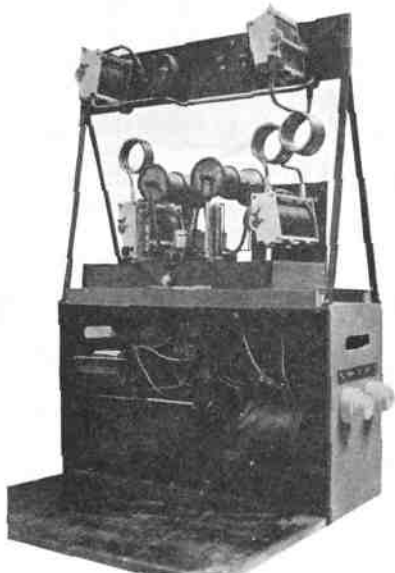

Rear View, with Back of Power Cabinet Removed

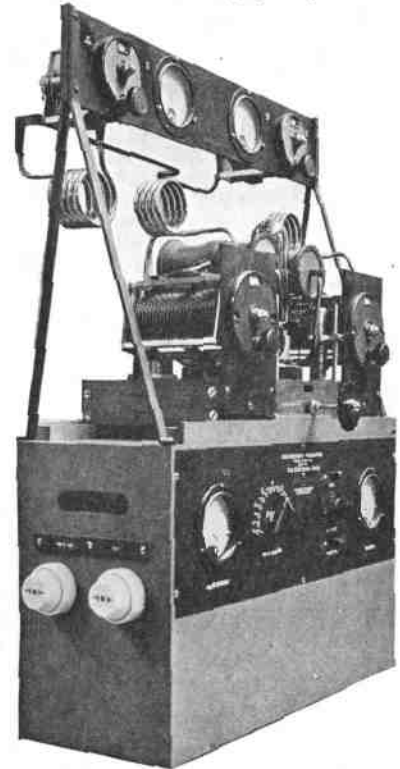

Front View of Transmitter, Showing Power Panel

by-pass condensers and the tube sockets. The antenna-counterpoise panel has two tuning condensers, two thermo couple radiation ammeters and the antenna coupling inductance. The chassis slides on a pair of brass channels with a rack and pinion gear operated from the handle shown in the picture. This enables moving the entire transmitter back and forth so as to get the proper coupling without moving any of the important wires in the high frequency circuit.

The chassis and the antenna panel are fastened to the top of the power panel which contains the filament and plate transformers, auto transformers, together with the meters and necessary control switches. The cabinet housing the power apparatus has a hinged lid so that the entire transmitter can be swung out, exposing the connections and the back can also be removed to facilitate inspection of the wiring. A list of parts gives the dimen-

supplying at least 10 volts, 7 amperes. The filament voltage is controlled by a primary rheostat with an a. c. voltmeter having a 15 volt scale. If Western Electric Type 211-D tubes are used a filament ammeter should be used, in series with one side of the filament supply. The ammeter should have a 10 ampere scale as the approximate current drain will be 6 amperes.

Plate supply to the tubes is obtained through a center tapped transformer having a 110 volt primary and 3,000 volt secondary. To obtain various adjustments of power without taking out taps on the transformer, an auto transformer is connected across the primary circuit as is shown in Fig. 1 so that any voltage from 50 to 110 can be applied to the transformer primary. This auto transformer is a standard Westinghouse sign lighting transformer and can be obtained from almost any large electric supply house handling electrical contractors' supplies.

The grid and plate condensers are Faradon UC-1846 and are .000037 mfd. This capacity is smaller than is often used in this circuit but is adequate for any wave-length up to 80 meters.

The pictures show the general arrangement of apparatus. The transmitter consists of the wooden chassis on which are mounted the grid and plate condensers with associated inductances, the grid and plate fixed condensers, grid leaks and chokes, as well as the filament

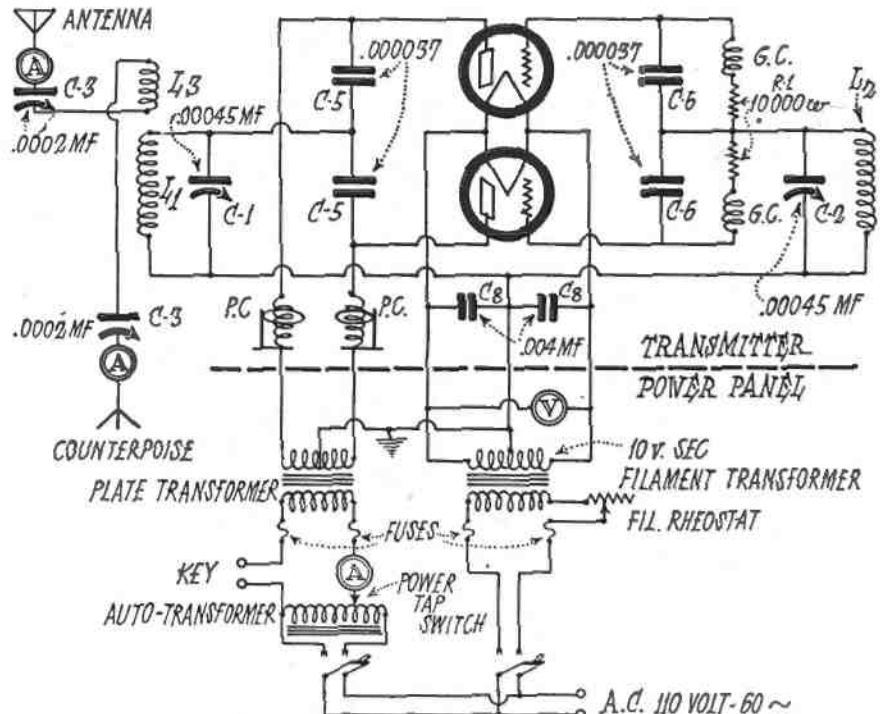

Fig. 1. Wiring Diagram of Tuned Grid-Plate Transmitter.

The Q. R. S. Power Supply Unit

THE new QRS rectifier tube has an output of 400 milliamperes at approximately 320 volts, and when used in conjunction with a suitable power transformer and filter system, is capable of supplying any receiving set whose filaments are wired in series, with filament and plate current, as well as grid voltage.

The circuit for a power plant employing a QRS tube is shown in Fig. 1, while

volts, when 300 to 400 milliamperes are being drawn from the rectifier, and this voltage is reduced to the various values required for *A*, *B* and *C* supply, by means of a tapped resistor, designated as R_1 , R_2 , R_3 and R_4 in Fig. 1. This resistor permits 250 milliamperes to flow through the filament circuit connected to the terminals marked plus and minus *A*, and the various taps between the plus *A* and the plus filter terminal permit the

condensers cannot all be connected to a common point, the negative *A* circuit ordinarily having parallel filaments.

The antenna coil is tuned with a single condenser, C_1 , and the remaining three tuned circuits are tuned with a three gang condenser, C_2 to C_4 , so that the common rotor of the latter condenser group goes to the positive of the

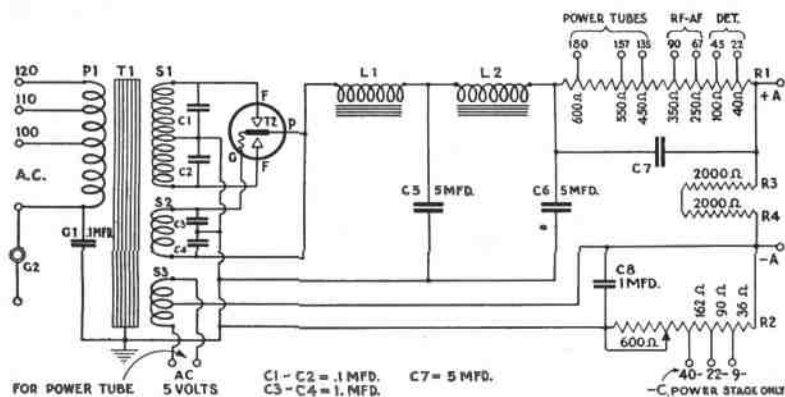

Fig. 1. Circuit of QRS Power Supply Unit.

the circuit of a typical 7 tube receiver adapted for use with the power plant is shown in Fig. 2. A picture of the assembled power plant is also shown, with the various pieces of apparatus marked with numbers corresponding to those in the circuit diagram. Referring to Fig. 1, T_1 is the power transformer, with 100-120 volt primary, 720 volt plate secondary with center tap, 5 volt filament lighting secondary for the power tube in the receiver, and 4 volt filament secondary for the rectifier tube. The rectifier tube filament secondary is shunted by two 1 mfd. by-pass condensers in series, and the plate secondary is shunted by two .1 mfd. condensers in series, for use as buffer condensers. The filter consists of two choke coils of at least 5 henries each, with d.c. resistance of not over 100 ohms, and used in conjunction with a 15 mfd. condenser bank.

The output of the filter is about 225

obtaining of suitable *B* voltages for the various tubes in the receiver. The resistor connected between the minus *A* terminal and the negative end of the filter circuit provides *C* voltage for the power tube, and is used in connection with a 600 ohm variable resistance to adjust the current flowing through the entire resistance group to the right value.

The receiver shown in Fig. 2 uses six type *A* tubes, with filaments requiring .25 amperes at 5 volts each, so that a total of .25 amperes at 30 volts will be needed if all the filaments are wired in series. The power tube may be either a type 112, or a type 371, and has its filament lighted from a 5 volt secondary of the power transformer. The three stages of tuned r.f. amplification in this receiver are connected somewhat differently than normal, on account of the fact that the filaments of the tubes are in series, and the rotors of the tuning

detector filament. This permits two controls, with each r.f. tube grid return to its negative filament, the tuning condenser C_2 being connected to its tube filament by means of a by-pass condenser, C_{10} , of .01 to .02 mfd. To provide grid voltage for the first audio tube, advantage is taken of the drop across the filament of the second audio tube, and grid voltage for the latter is had from the drop across an 18 ohm fixed resistance R_5 , placed between the negative *A* supply and the filament of the tube.

Volume control for the r.f. tubes is obtained by placing a 6000 ohm potentiometer between the 90 volt *B* terminal and the positive *A*, so that the plate supply leads from the three r.f. transformers are connected to the potentiometer slider, and its position varied so as to control the plate voltage to these tubes, and thereby control the volume. The grid return for the detector tube is made through a 2 megohm leak, R_2 , to the positive end of the filament. If a type 300-A detector were to be used, this resistance should be connected to the negative end of the filament in order to obtain the most satisfactory operation of the tube as a detector.

The first two audio stages are coupled with impedances, x_1 and x_2 , which should be at least 100 henries each. The third stage of audio has a high quality transformer, and the output circuit may be either impedance coupled, as is shown in the diagram, or an output transformer. If impedance coupling is used, a choke coil capable of carrying at least 25 milliamperes should be used, to bypass the d.c. around the windings of the loud speaker.

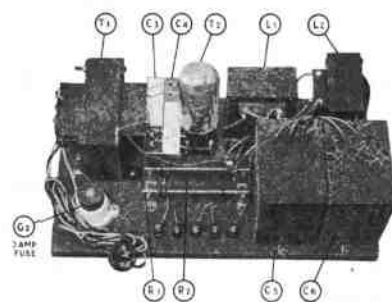

A, B and C Power Plant With QRS Tube.

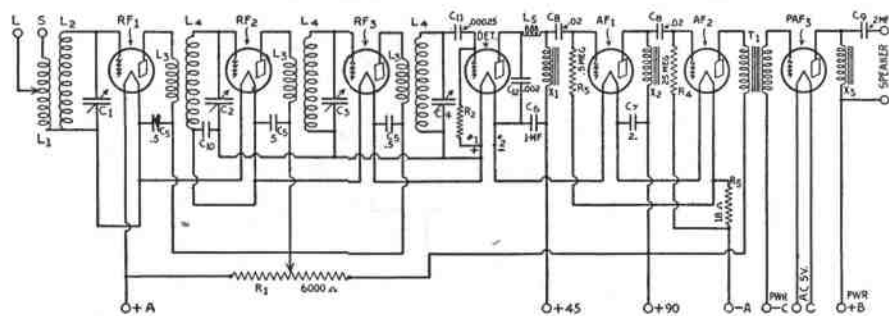

Fig. 2. Receiving Set Circuit For Use With QRS Rectifier Tube.

THE MAKING OF PAPER CONDENSERS

The manufacture of the large capacity condensers used in the filter circuits of *B* eliminator units requires an elaborateness of apparatus and a watchfulness of methods that is well-illustrated by the equipment and procedure used by the Leslie F. Muter Company. Although the finished product is apparently simple, consisting of alternate layers of metallic foil and special paper, extreme



Fig. 1. Left Side View of Power Winding Machine.

care has to be exercised in every step of the process so as to insure the satisfactory performance of the final product when subjected to the exacting requirements of socket power operation.

Even the building in which the condensers are made must be sealed to exclude dust and moisture. Most of the



Fig. 2. Front View of Winding Machine.

individual machines are likewise enclosed so as to keep foreign particles away from the paper and foil. Thus in Fig. 1 may be seen a side view of one of the power winding machines which has been opened up so as to show the spindles with their rolls of condenser tissue and foil. These spindles as well as the guides which direct the sheet movements are set on ball bearings so as to minimize the friction and give a uniform tension in the condenser windings. On top of each roll is also a tensionator to keep the paper and foil at

the proper tension so as to insure uniformity.

In the actual operation of this machine the windings are pulled vertically downwards by the motor-driven mandrel shown in Fig. 2. The open cover is shown horizontally only to illustrate its construction. The exact number of turns in the condenser is at all times indicated by a revolution counter. A small stack of the windings may be seen at the left of Fig. 2. The eight large handles on the side of the machine as seen in Fig. 3 are used to align the spindles and the 16 small studded projections align the guides.

After the condensers are wound they are placed in the trays of the vacuum dryer shown at the left side of Fig. 4. Here they are heated for an hour with the door slightly open to assist radiation. The door is then clamped shut and the condensers are heated for four hours under a high vacuum which re-

moves any trace of moisture which may remain after baking. The picture shows the vacuum pump and gauges as well as the paraffine heater and the impreg-

(Continued on page 88)

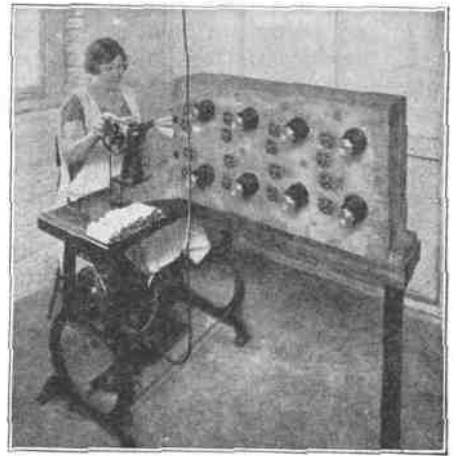

Fig. 3. Right Side View of Winder.

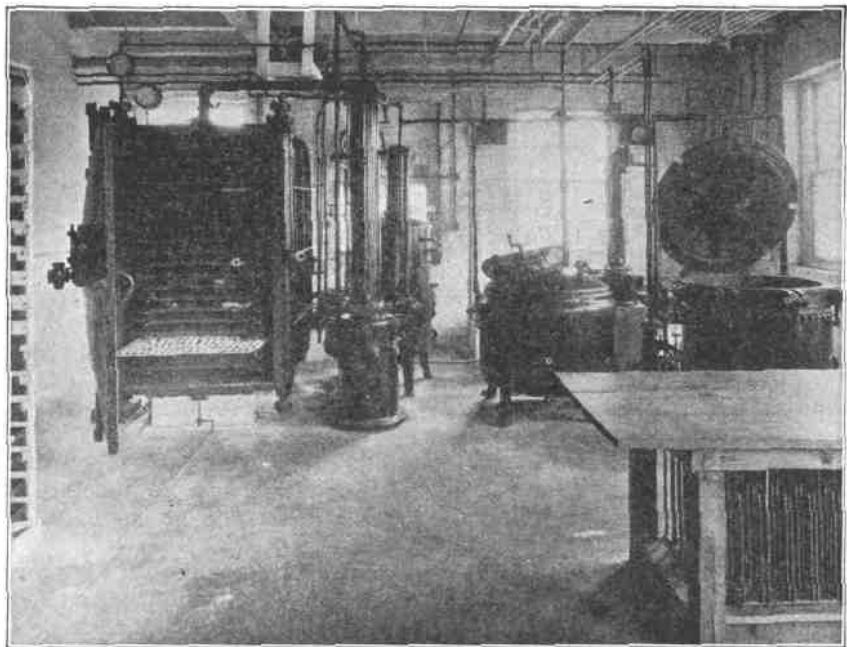

Fig. 4. Vacuum Dryer and Impregnator.

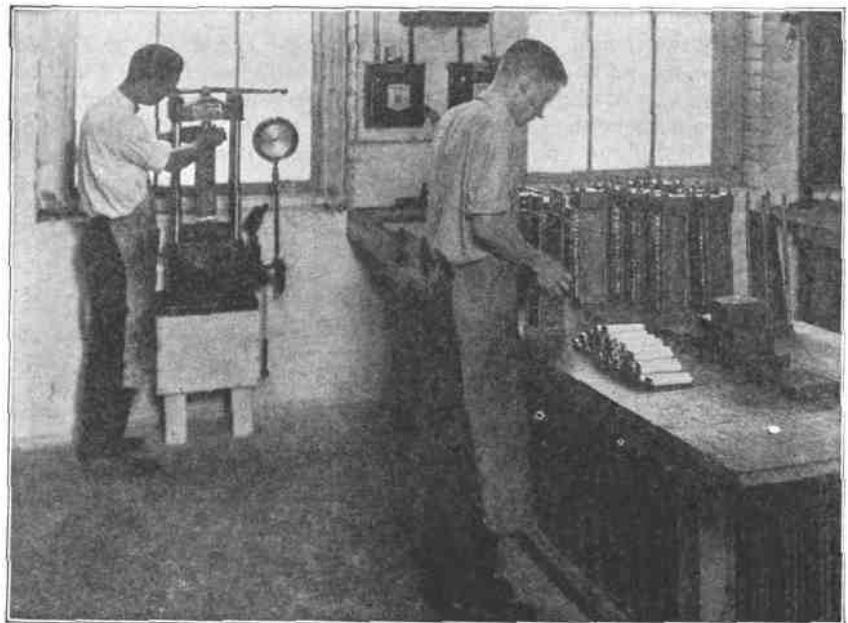

Fig. 5. Stacking Condensers for Hydraulic Press.

Keeping Step with Radio Progress

The Yaxley Mfg. Co., Chicago, Ill., celebrated its twenty-sixth anniversary in May of this year. Over this more than a quarter-century span the company has been a conspicuous figure in the development of equipment for electrical communication and in the production of instruments and mechanisms of great fineness and precision.

It was by a very natural evolution that the inventive, designing and manufacturing genius of the organization turned from the production of high-grade telephone equipment to the development of a superior line of radio products. And just as in the telephone field the company has enjoyed a reputation befitting its products and policy, so has its reputation in the radio field been enhanced by producing only the best

in design and construction and adhering to the strictest fair play among jobbers, dealers and the radio user.

Among the many products which the genius of Mr. Ernest E. Yaxley, President of the company, has given to the improvement of radio, the Air-Cooled Rheostat is a notable achievement. Built on an all Bakelite base, the large number of turns of special resistance wire permits an exceptionally fine adjustment without the use of vernier attachments. The resistance unit is suspended in air, contributing to cool and steady operation. The contact arm slides noiselessly over the resistance unit and because of the spring tension gives perfect contact. The precision with which this rheostat is made and the extremely fine adjustment

gives a volume control that can not be secured in any other way.

Another important and very recent development is the Yaxley Automatic Power Control. Where B eliminators and trickle chargers are used this is the monitor of the set. Unfailingly, as often as the set is turned on the trickle charger cuts out and the B eliminator is switched on. This automatic power control has been chosen as a component of many of the most prominent power packs now on the market and has been installed in thousands of the most satisfactory receivers in use today.



Yaxley Air-Cooled Rheostat

The Yaxley Cable Connector Plug is another innovation that has won instant and extremely favor-

able acceptance. One of the most beautifully finished radio accessories ever produced, it gives an instant, positive and accurate means of hooking up the battery leads and terminal connections through a neat cable harness and plug, contributing greatly to the neat appearance of the set and adding tremendously to convenience in operation.

Yaxley Radio Convenience Outlets are indeed a boon to the ambitious radio user. By means of appropriate outlets mounted on the back of a handsome brushed brass face plate a wide range of utility is provided. Batteries may be installed in any out of the way place and leads brought to the conven-



Yaxley Automatic Power Control

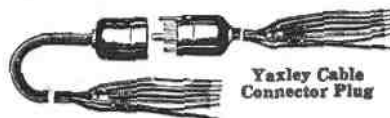

Yaxley Cable Connector Plug

ience outlet. By means of the Yaxley Cable Connector Plug the set may be connected to the outlet and all unsightly wires kept under cover. Or leads may be brought from the set to outlets located in any room in the house. Provision is also made for antenna and ground connections. These outlets fit any standard switch box and are furnished either singly or in gangs of various combinations.



Convenience Outlet Yaxley Radio

Many leading manufacturers of radio receivers have adopted as standard the Yaxley No. 10 Midget Battery Switch. This little item plays an important part in set operation. It may be mounted in any position to fit the wiring layout. Made of the finest materials throughout, of ample dimensions and with great precision it gives a lifetime of service and eliminates some of the most irritating faults that often develop in an otherwise perfect receiver.



Yaxley No. 10 Midget Battery Switch

Yaxley Jacks, Switches and Jack Switches have long been famous. And because of the fine service given by the standard equipment Yaxley is called upon continuously and has set up a special department for the production of special switches of every description.

YAXLEY

APPROVED RADIO PRODUCTS

Approved Radio Products are favored by the leading jobbers and dealers because they invariably give the ultimate in customer satisfaction.

For success in set building and set operation ask for Yaxley Approved Radio Products.

YAXLEY MFG. CO.

Dept. A—9 South Clinton Street
Chicago, Ill.

Manufacturers of

JACKS
SWITCHES
RHEOSTATS
POWER CONTROLS

CABLE CONNECTORS
SWITCHING RHEOSTATS
CONVENIENCE OUTLETS
RESISTANCE UNITS

PANEL LIGHTS
PHONE PLUGS
POTENTIOMETERS
AND OTHER PRODUCTS

Tell them that you saw it in RADIO

Beyond

The "Model DX" INFRADYNE—The Most

The illustration shows the new combination 5 or 10 tube receiver in its artistic copper shielded, crystalline finished cabinet with polished hardwood base. The entire receiver measures only twenty-six inches in length and 11 inches in depth—a foot shorter than last year's model. The copper case fits snugly into grooved spaces on the baseboard. Easily removed for inspecting the interior of the set.



Various tones of bronze are used for finishing the control panel, sharply contrasted to the neutral finish of the shielded cabinet. Raised molding panels on the front, top and sides of the cabinet add beauty and grace. Here is the receiver of tomorrow—the Perfected Infradyne.

DISTANCE!

The Infradyne circuit is acknowledged to be the best distance getter ever discovered. The Model DX Infradyne—the perfected Infradyne of 1928—will get more distance than any other set made, regardless of circuit or number of tubes used.

If you are not getting DISTANCE you are missing the biggest thing in radio. IT CAN BE DONE. Get a Model DX Infradyne and know radio as it really is.

New Features —

1. Five or ten tube reception.
2. Illuminated Drum Control.
3. Tuned R. F. unit supplied completely wired and balanced.
4. Completely assembled and chassis wired.
5. No soldering—equipped with screw terminals throughout.
6. The cabinet problem solved! Beautiful, shielded metal cabinet is part of the kit.

Send for illustrated descriptive folder telling all about this wonderful new set.

Eight Distinctive Features Not

WIRING

The 1928 Infradyne comes to you with Chassis Wired. The battery connections, audio amplifier connections and current supply cable are all attached securely to the metal base by means of novel connection blocks. The vacuum tube sockets are also secured to the chassis. The builder of this new receiver hooks-up the Infradyne Amplifier, R. F. Unit and Tapped Inductance Unit and his set is ready for operation. By means of the new method of chassis wiring it is now possible to make changes in the circuit as the constructor desires. This new idea in wiring greatly adds to the beauty of the receiver. All of the wiring is BELOW the BASE. Suitable holes are punched in the chassis for bringing the connection leads directly to the various units of the receiver.

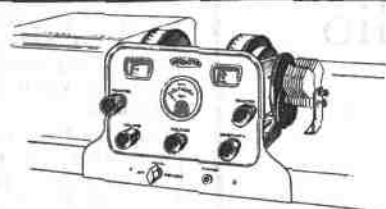

Unit Control Panel

Here you see pictured the control panel with its beautiful bronze plate. On this panel we mount the voltmeter, drum dial controls, dial lights, 5 or 10 tube switch, selector controls, volume and sensitivity controls, plug for headphone operation, on-off switch and filament control. The meter, knobs, dials and all other parts as illustrated are mounted on the control panel for you before the kit is shipped. This control panel is also completely wired for you. Just slip it in place—that's all. A resistance protects your tubes. The headphone plug is useful for tuning in the hard-to-get stations.

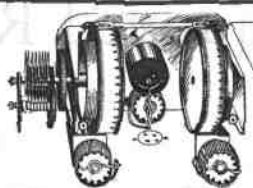

Control Assembly

The rear view of the control panel assembly gives you a good idea of the unusually rugged construction employed in the design of this all-important part of the receiver. "Built Like A Battleship." Note the method used for securing the rheostats to the panel. Both drum dials have heavy brass supports. The lights for indirectly illuminating the dials can be seen directly on top of the drums. These lights are wired for you in our assembly rooms. The Remler condenser is attached directly to the dial. The entire control unit is rigidly secured to the chassis.

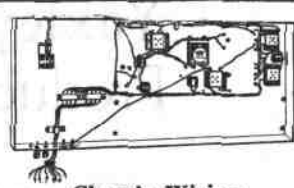

Chassis Wiring

Here is where we have taken the grief out of home-assembled radio. We supply you with a wired chassis as illustrated. Note the extreme simplicity of wiring this 10 tube receiver. The harness-cable method is used. A battery cable goes with each assembly. This cable is clearly marked with tabs. Socket wiring is also concealed below the metal chassis. The antenna coupler, fixed condensers and other small parts are secured to the chassis before it is shipped to you. These units are wired. Right here you save hours of time. Changes to the circuit can be easily made. Colored wiring system makes such changes possible.

SHIELDED UNIT CONSTRUCTION WITH SHIELDED

Comparison

Beautiful Receiver Ever Offered for Sale

The arrangement of parts is such that the receiver will function at its maximum efficiency. For this reason we do the assembly work for you. All parts are mounted directly to the metal chassis by means of heavy screws. In appearance this new receiver stands out in a class by itself. Compare it with any receiver on the market, regardless of price, size or make.

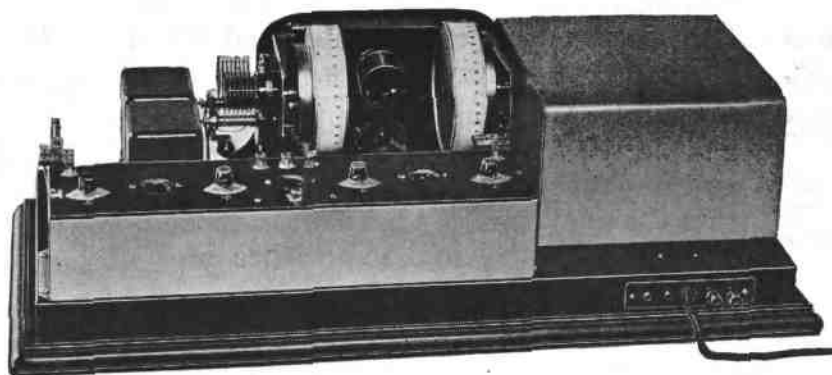

Rear View

The rear view assembly of the new Infradyne gives you a good picture of its massive construction. Note the absence of unsightly wiring. It is a clean-cut job throughout. Highly finished copper cases are mounted on a dull black metal chassis. The Infradyne is shipped to you in assembled form exactly as illustrated. Antenna and ground posts and terminals for loudspeaker connections are shown in the lower right corner of the chassis. These terminals are insulated from the chassis. You connect the wiring terminals to the R.F. Amplifier Unit, Infradyne Amplifier and Audio Unit—and you are ready to tune in on stations you never heard before.

Selectivity!

No need to wait for the Radio Commission to act. Interference ceases when the Model DX Infradyne is installed. It will cut through any station on the air.

YOU CAN BUILD IT IN AN HOUR!

Comes to you assembled, and with CHASSIS WIRED. Only a screw driver and pliers needed to finish the set. NO SOLDERING.

Price **\$179.50**

WITH SHIELDED CABINET

f.o.b. Oakland, California

IMPORTANT NOTICE

All parts sold separately to those who wish to bring last year's Infradyne up-to-date. Write for list of what you will need. Include list of your present parts in the letter.

Radio Constructors Corporation
357 TWELFTH STREET OAKLAND, CALIF.

Found In Any Other Receiver

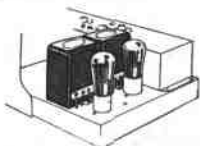

Amplifier

Another outstanding feature of the new Infradyne is the two stage audio amplifier. This unit is assembled and wired for you before the set is shipped. Each transformer is carefully tested and ok'd before it goes to the assembly room. The tone quality of an Infradyne, as any Infradyne owner will tell you, is excellent. Eight holes are punched in the chassis for running the wiring to the audio unit. The sockets are wired by us.



Shielded Case

One of the most advance steps to 1928 radio is the use of a shielded cabinet for housing the entire receiver. The cabinet is of COPPER, beautifully embossed and decorated with artistic molding. Finished in crystalline. A genuine, sturdy table-style cabinet for the home. The entire set can be slipped into a console without removing the copper cabinet. This cabinet "re-shields" the complete receiver. The wise radio man knows what this means. A beautiful hardwood base goes with each cabinet. This saves you \$20 to \$30 for a cabinet.

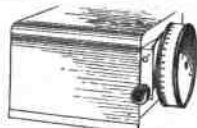

R. F. Unit

A radio receiver in itself. In this shielded unit by Remler we give you a three gang Remler condenser, new Remler inductance coils, sockets and connection terminals. The coils have a new and novel method of coupling, automatically made by the rotation of the condenser. The set is thereby made efficient over the entire broadcast wave band. It's revolutionary. Three individually shielded compartments. Re-shielded with the copper case as illustrated. Drum dial is attached to the unit.

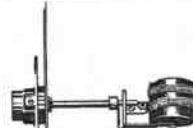

Coupler

The use of trimmer condensers in the 1928 Infradyne is no longer necessary. The new Remler antenna coupler makes the operation of this receiver non-critical. Three antenna taps are provided for long-medium-short-antenna variations. Extreme selectivity is secured by adjusting the coupling of this device. You now have perfect control of this new 10 tube Infradyne.

DELIVERIES

The new 1928 Infradyne assembly will be ready for the market early in August. Deliveries will be made in rotation. Orders now accepted for early delivery. C. O. D. orders will be taken when 50% cash accompanies order. Deliveries by express, F.O.B. Oakland, California. Remit by postal money order, cashier's check or cash. The new assembly is securely packed in two large containers. Shipments can be safely made to any part of the world. Standard Cunningham or Radiotron tubes can also be supplied with each receiver for \$22.25. This includes ten selected tubes, each marked for use in the proper part of the receiver.

CABINET ASSURES MAXIMUM SELECTIVITY

Tell them that you saw it in RADIO

Silent Power for Fine Receivers



Heavy Duty "B" Eliminators

Type 611—for 110-volt, 60-cycle current—\$61.50, type BH Rectifier tube, \$6.00 extra.

Type 610—for 220-volt, 40 to 50 cycle current—\$61.50, type BH Rectifier tube, \$6.00 extra.

Type 614—same as type 611 except that it includes a special non-motorboating circuit for use with resistance or impedance-coupled amplifiers. Same price as type 611.



Type 1666 Individual Choke

designed for use in "B" eliminators and in the output circuits of power tubes. Low D.C. resistance and high inductance gives exceptionally fine filtering action. Enclosed in crystalline metal case.

Price \$5.00



Type 850 Heavy Duty Chargers

for use with one or two type "A" Rectifier units, giving a 2½ ampere charging rate with one "A" unit and a 5 ampere charging rate with two "A" units.

Price of charger \$10.00; 1 type "A" rectifier unit \$4.50 extra; 2 type "A" units \$9.00 extra.

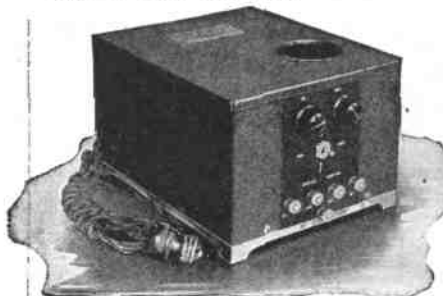

Type 612 "B" Eliminator

is designed for comparatively low power work where a voltage of more than 180 volts is not required. For operation on 110-volt, 60-cycle current. Provided with three taps, two of them variable, and an input transformer ratio control switch giving two voltage ranges for each tap. Price \$36.50, type BH rectifier tube \$6.00 extra.

The wide acceptance and increasing popularity of battery eliminators for radio receiver operation is an unmistakable sign that the radio public is appreciating the uninterrupted and uniformly fine results that can be obtained when using power supply devices.

In selecting power supply units, remember that the success obtained depends on the quality of the apparatus used and that the quality of the apparatus depends on the reliability and experience of its manufacturer.

Whether you decide to buy a complete factory-made outfit or to build one at home from parts, the most dependable power equipment to use is

MAYOLIAN

FOLDER GIVING COMPLETE DETAIL ON REQUEST

MAYOLIAN CORPORATION

1668 Webster Avenue

New York, N. Y.

Specialists in Power Equipment

EXCLUSIVE SALES REPRESENTATIVES

ARTHUR H. LYNCH, Inc.

1775 Broadway at 57th Street

General Motors Building

New York City, N. Y.



Power Supply Transformers

Designed to provide the proper operating voltage for a "B" or "BH" type rectifier tube. Center tapped secondary. Also a tapped primary winding giving two voltage ranges for each terminal.

Type 875—for 110-volt, 60-cycle.....\$7.00
Type 876—for 110-volt, 25-cycle.....\$9.00



Type 1668 Tone Filter

used in the plate or output circuit of a radio receiver, it stops the heavy direct current in the plate circuit from flowing through the loud-speaker windings, preventing magnet depolarization, eliminating distortion and improving tone quality.

Price \$6.50

Driver Unit for A. C. Tubes

The Mayolian Corporation now makes a Driver Unit to work with any type of set employing A. C. tubes. This driver unit employs the type 612 "B" eliminator with special additional transformers for supplying the filaments of the A. C. tubes. Prices of these units vary, depending on filament current drain, number of tubes and type of tubes used. In ordering or writing for detailed information, mention the type of A. C. tubes used and also mention the type of circuit you are using.



Type 607, D. C. Battery Eliminator

is ideally suited for any type of current where 110-volt to 220-volt direct current is available. The Famous Mayolian Dual Filter system which provides constant, unvarying, even flow of power is a feature of the circuit used in this eliminator. A variable control is provided for the detector voltage. Price \$35 complete.



Type 885 Tran-Choke

is a power supply compact, containing in one unit, a heavy duty type eliminator power transformer and two heavy duty chokes. Transformer secondary center-tapped. Additional winding to furnish filament current for 71 type tube. Completely enclosed in metal case. Price \$15.00.



Condenser Blocks

are furnished in a variety of individual and combination units. They are encased in metal containers, sealed against weather conditions. Made in two styles: for high power work to withstand 1,000 volts D. C. continuously or a flash test of 2,000 volts. For low power work to withstand 500 volts continuously or a flash test of 1,000 volts. Detailed specifications, types and prices on request.

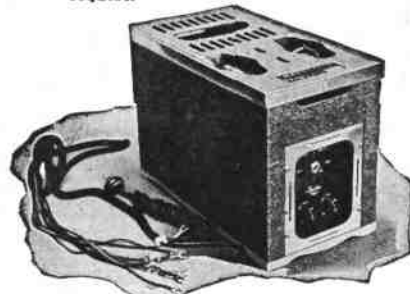

Combination "A" and "B" Eliminators

are designed to operate receivers direct from the current mains, furnishing both "A" and "B" current. Type 800 for use on 110-volt, 60-cycle current. Price \$90 complete with rectifier tube and units. Type 801 for use on 220-volt, 40 to 50-cycle current. Price \$95 complete with rectifier tube and units.

The Complete Resistance Line



FILAMENT EQUALIZERS

are used in the filament circuits to keep the filaments at their best operating points. The Lynch Equalizer consists of a special alloy encased in a glass cartridge having metal endpieces. The cartridge can be inserted or removed from its mounting so that the proper resistance may be employed for different tubes or combinations up to six "A" type tubes. Equalizer cartridges are furnished complete with mountings. Filament Equalizers, all sizes—\$1.00 complete with mountings.



TYPE "P", HEAVY DUTY RESISTORS, WIRE-WOUND IN PORCELAIN
Lynch Type "P" heavy duty resistors are conservatively rated at 20 watts carrying capacity; are designed for power circuits where the use of high voltages make ordinary resistors impractical.

Made in a variety of sizes, carefully selected to meet the requirements of the average eliminator and other power circuits. The stock sizes range from 2,000 to 100,000 ohms.

Any other size or form to suit special requirements can be made to order. Lynch Type "P" heavy duty, wire-wound resistors—\$1.25 to \$4.00, according to size.



SPECIAL, TAPPED WIRE-WOUND, HEAVY DUTY RESISTORS

There is a special Lynch Heavy Duty, Wire-Wound Resistor for every popular "B" eliminator and Power Pack. Illustrated is a sample of this type of resistor. Made to AmerTran specifications and guaranteed to be accurate as well as to perform satisfactorily. Units for use in the AmerTran, Mayolian, Thor-darson and Silver Power Packs are but a few of the types available, as well as resistors for use with the new Mayolian R-71 AC Driver Unit.

Tapped resistors may be had in any resistance value with any number of taps on special order. Lynch AmerTran Tapped Heavy Duty, Wire-Wound Resistor—\$8.50.



LEAK-PROOF SINGLE MOUNTINGS are made of highly polished genuine Bakelite. This fact, coupled with the skillful design gives the mountings their extremely low surface leakage. The springs are made of heavy phosphor bronze, nickel-plated. The head of the screw is sunk well into the base so as to permit mounting the base on metal surfaces without any possibility of short circuit, a feature found in no other mounting. Spring and soldering lug are one piece, thus eliminating poor and noisy contacts. Single mounting—35 cents.

LYNCH RESISTORS

The Resistance Line Backed by Years of Experience.

By focusing the efforts of an organization trained in the development and production of quality resistors, ARTHUR H. LYNCH, Inc., has succeeded in bringing on the market the most complete line of resistance units.

This line includes every type of resistor required for receiving, transmitting and power supply circuits.

The enthusiastic, widespread acceptance of Lynch resistance products by manufacturers, writers, engineers and fans is a fair indication of the quality of these products.

Manufacturers and engineers have placed the stamp of approval on Lynch products after conducting exhaustive tests on competing apparatus.

ARTHUR H. LYNCH, INC.

1775 Broadway at 57th Street
General Motors Building, New York, N. Y.



RESISTANCE-COUPLED AMPLIFIER KIT

The Lynch Resistance-coupled audio frequency amplifier kit contains all the essential parts for building a high quality resistance-coupled amplifier unit.

When used with the new high mu tubes, only this amplifier will give full volume over the entire audio frequency range, from the lowest to the highest note. The cost of the complete kit is less than that of a good transformer.

Price of complete kit—\$9.00.



GRID SUPPRESSORS

are special resistance units designed for use in tuned radio frequency circuits to stop oscillation and improve reception. Suppressors are furnished complete with mountings in resistance values of from 100 to 1890 ohms varying in even hundred units. Price, all sizes—\$1.50 complete with mounting.



TYPE "G." HEAVY DUTY RESISTORS, WIRE-WOUND ON GLASS

The Type "G" heavy duty resistors are designed for use in circuits where the ability to withstand high voltages and heavy currents is not of primary importance. They may be used to advantage in eliminators from which the output is 180 volts or less. They are also adapted for use as grid biasing resistors in high voltage eliminators and power circuits.

This type of resistor is available in the same resistance value as the Type "P" resistors but is conservatively rated at 7 watts carrying capacity. Special sizes may be had to order.

Lynch Type "G" heavy duty wire-wound resistors—\$1.00 to \$3.75, according to resistance value.



METALLIZED RESISTORS

give continuous, conductive, non-arcing, noiseless and permanent resistance. They are available in sizes ranging from .25 to 10 megohms at 50 cents each; .012 to .2 megohms at 75 cents each and .005 to .01 megohm at \$1.00 each.

For heavier duty there is a specially designed, Type "C" Metallized resistor, made in sizes from .005 to .1 megohm. For use in battery eliminator circuits and resistance-coupled power amplifier plate circuits. Price of Type "C" Metallized resistors, \$1.50.

There is also a Type "D" Metallized resistor for comparatively heavy work, made in a wider range of resistance values ranging from .005 to 1 megohm at \$1.25.

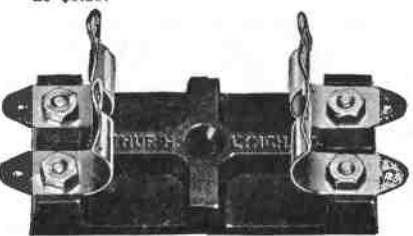

LEAK-PROOF DOUBLE MOUNTING find their greatest application as coupling units in resistance-coupled amplifiers. They are not provided with condensers in the base because each audio system requires a condenser of different capacity. The use of Lynch double mountings permits the user to employ any desired capacity.

Their rugged construction, single-hole mounting feature, low surface leakage, mechanical strength and rigid mountings of the spring make them the best double mounts available anywhere. Double mounting—50 cents.

BUMBLEBEE

The Ideal "HAM" Transmitter

Described by Gerald M. Best
in May "RADIO"

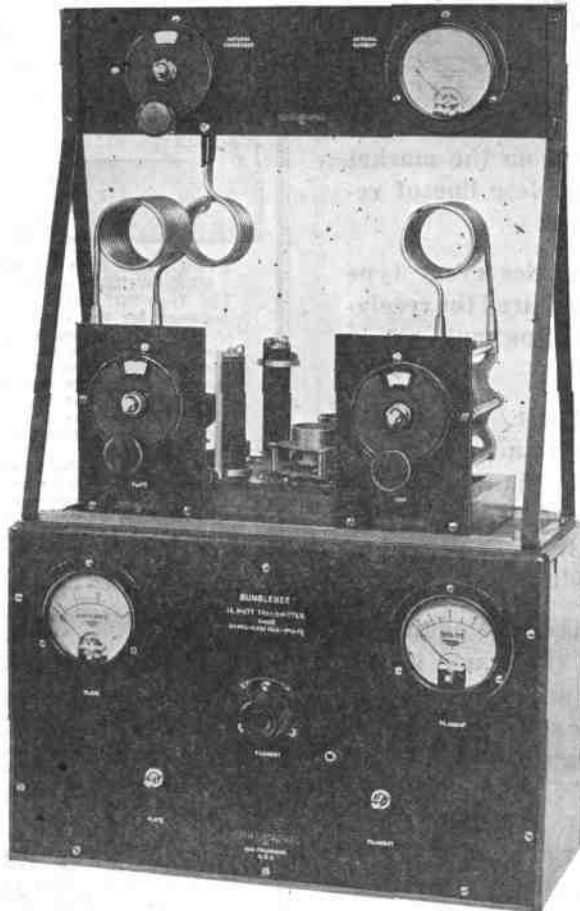

Secure Parts Complete From Us

DO NOT FAIL TO SEE IT AT THE SHOW
ASK US ABOUT IT

SODDERDIPT LUGS ARE BEST



219-221-223 Natoma Street, San Francisco, Calif.

MANUFACTURERS FOR MANUFACTURERS

50 WATT TRANSMITTER

(Continued from page 62)

by $\frac{1}{4}$ in. brass strip arranged on a supporting rod so that any section of the choke can be short circuited and the inductance of the choke set at a value best suited for the frequency at which the transmitter is to be operated. These chokes are mounted on the bakelite panel supporting the tube socket with the plate choke nearest the front of the panel. The grid and plate condensers are supported by the heavy copper tubing which is used for connecting leads. The inductance coils are all $2\frac{1}{2}$ in. in diameter of $\frac{1}{4}$ in. copper tubing with 4 in. stems. The stems are tipped with $\frac{3}{8}$ in. copper sleeves made from $\frac{1}{8}$ in. rod and suitable fittings are attached to the air condensers so that the coils can be easily plugged in. For covering the entire group of amateur bands, the following coils will be needed: 1-12 T, 1-11 T, 1-10T, 1-9T, 1-8T, 1-6T, 2-5T, 1-4T, 1-3T, 1-2T, 1-1T.

The filament, plate supply, and other low frequency circuits are wired with No. 12 enameled wire. The high frequency leads are all $\frac{1}{4}$ in. copper tubing or heavy copper strips, depending upon the location of the equipment. Flexible leads connect the filament and plate supply to the transmitter so that the chassis can be moved back and forth without interference from the wiring.

Keying is done entirely in the primary of the plate transformer instead of in the center tap between the secondaries of the two transformers.

The tuning of this transmitter is identical with that of the "Bumblebee" described in the May issue, and hence does not need further elaboration here.



At 9BKN, 348 E. Tamarack Street, Ironwood, Michigan:

(20 and 40 meters)

4dv, 4ft, 4fu, 4jl, 4nh, 4ob, 4px, 5acl, 5avs, 5aqu, 5bh, 5ok, 5pk, 5rg, 5ut, 5agr, 5bl, 5ecr, 5ctz, 5czs, 5ec, 5rr, 5zat, 7df, 7et, 7tj, nc-lad, nc-2al, nc-3cc, nc-5nj, nc-9be, nm-1j, nm-1n, nm-5b, nj-2px, nn-1nic, nn-m3y, np-4sa, nr-2fg, nr-cto, sa-cb8, sc-2ah, sc-2sa, sc-2ar, sc-2bl, se-1fg, oz-2ac, oz-2ae.

At 6CIB, Yosemite Valley, Calif.

oa-2cs, oa-2yi, oa-2lk, oa-2bk, oa-2sh, oa-2bb, oa-2uk, oa-2mh, oa-2sz, oa-2dy, oa-2rx, oa-2tm, oa-2rt, oa-2no, oa-2rc, oa-2sa, oa-2iy, oa-2cm, oa-2ds, oa-2gw, oa-2nj, oa-2go, oa-2cy, oa-2ro, oa-2wb, oa-2yj, oa-2am, oa-2ef, oa-3kb, oa-3my, oa-3rm, oa-3gm, oa-3yx, oa-3ax, oa-3hl, oa-2tm, oa-3bq, oa-3de, oa-3xo, oa-3be, oa-3es, oa-4an, oa-4lo, oa-4nw, oa-4lj, oa-4cg, oa-4bd, oa-4aw, oa-5kn, oa-5wh, oa-5bw, oa-5lf, oa-5hg, oa-5dx, oa-5da, oa-5sh, oa-5wp, oa-5bg, oa-5rm, oa-7cw, oa-7cm, oa-7dx, oa-1ao, oa-1as, oa-1av, oa-1am, oa-1ax, oa-1fe, oa-1fb, oa-1fg, oa-2bg, oa-2ac, oa-2bx, oa-2xa, oa-2ac, oa-3af, oa-3ar, oa-3am, oa-3aj, oa-4aa, oa-4an, oa-4ac, oa-4am, oa-4ak, oh-6aff, oh-6axw, oh-6acg, oh-6aar, oh-6buc, oh-6be, oh-6cxy, oh-6clj, oh-6dcf, oh-6dea, oh-6dbl, oh-6kq, oh-6nl, oh-6oa, oh-6tg, oh-6m2, oh-6fl, oh-6xl, op-1hr, op-1au, op-1bd, op-1dl, op-1as, op-1ah, op-1cw, op-1rc, op-3aa, op-3ac, op-wuaj, op-cds, od-pkl, od-pa2, od-sk2, nm-jh, nm-1j, nm-1aa, nm-9a, nm-1n, nm-1x, nm-10, nm-1af, nm-1af, nm-5b, nm-bx, na-7kn, na-7am, na-7nm, na-7abe, na-7fzh, nj-2ys, nj-3ab, na-2kp, nl-4x, aj-1sq, aj-1sk, aj-1kk, aj-1ts, aj-1km, aj-1am, aj-1tt, aj-8aa, aj-joc, ac-2ff, ac-9aa, af-hva, af-8fok, am-2ae, sc-2ab, sc-2ag, sc-2ah, sc-2as, sc-2ar, se-2aw, se-2bl, se-2ld, se-3ij, se-3ag, se-3tc, su-1cd, su-1cg, su-2ak, sa-1ff, sa-1fc, dw4, sa-dh2, sa-hd4, sb-lax, sb-law, sb-lap, sb-lar, sb-lib, sb-lak, sb-lac, sb-2ak, sb-2af, sb-2ag, fo-A6n, fo-a5o, fo-a4e, fo-a3b, fo-a2h, ef-8ix, ef-8yor, ef-8grt, eg-2sz, eg-2lz, eg-2nm, es-2co, eb-4ww. Will QSL to any of the above, on request, QRK my 50 watter on 39 meters?

Radio Pioneers Expanding Their Organization

Having demonstrated during the past five years its ability to provide the radio public with receivers and parts of high quality, the Bremer-Tully Manufacturing Co., of Chicago, is now engaged in expanding its organization to more closely cement relations with the dealer and consumer.

This program is of a progressive nature in keeping with the sound judgment which has characterized the rise of this organization from that of a radio pioneer in the early days to that of a healthy, effective and respected radio manufacturer.

Most interesting from the dealers' standpoint is the fact that through accurate judgment of the market requirements, careful design and a sound merchandising policy the Bremer-Tully organization has never over-produced, and as a consequence the trade has never known of a case of "dumping" during the slack season.

Testifying to the stability of the B-T parts it is interesting to note that the torostyle coils used in the Bremer-Tully Power Six kit (which succeeded the Counterphase Six kit) are now going in their third season without any changes being made in their design or principle. These coils, as well as the tandem condensers, were developed for the Counterphase Six. When the public urge for power tube operation came, the kit was changed only enough to embrace the use of the new power tubes. Another point of interest is that the single rotor condenser which serves admirably for all types of circuits, is now in its fifth year of production without any change being made. The fact that this last named article has been catalogued for five successive seasons gives an indication to the public of the permanency of the Bremer-Tully line.

Those who derive their greatest enjoyment from the hooking up of apparatus in various circuits find the inductances found in the Power Six kit may also be used in other circuit arrangements. For instance, the type TA torostyle answers for all circuits where an antenna and secondary winding are required; the TC torostyle with its three windings serves for primary, secondary and counterphase winding circuits, while the T4 is the most flexible of all, having four windings for almost any circuit combination.

Building for permanency is again discerned in the case of the factory-built Counterphase Eight. This popular receiver is considered Bremer-Tully's greatest achievement and one in which the listening public is manifesting a great deal of interest. Using a basic circuit which has been thoroughly tried out in kit form and which has been endorsed by radio fandom, the makers of the Counterphase Eight have produced a quality receiver whose peer will be hard to find.

In the production of the B-Power Unit the Bremer-Tully interests felt the public was entitled to a power source which could be depended upon to the limit. While the unit was designed for the Six and Eight receivers, nevertheless it finds its application in any circuit in which a maximum voltage of 150 and maximum current of 60 milliamperes is desired. Voltage control of the unit is by fixed resistances which permit a known voltage at all times. A simple plug-in system permits variation of the overall voltage to cover the operation of any receiver up to a ten tuber.

Answering the demand of B-T fans for a factory built receiver at a medium price, and opening up an entirely new field to the dealer, Bremer-Tully is now marketing a new Counterphase Six, which embodies some of the essential features of the larger model.



The expansion program of the Bremer-Tully Manufacturing Co., has made necessary the appointment as Assistant to the President, of Mr. F. A. Hill who has been for the past year and a half in charge of the Editorial and Technical departments of Radio Age magazine. He will have supervisory charge of the Advertising, Publicity and Technical departments.



Recently appointed Assistant Sales Manager of the Bremer-Tully Manufacturing Co., Mr. C. L. Sleininger will devote his time to dealer sales. His past experience fits him well for this task as he was associated for two years with another set manufacturer, and was for several years a District Sales Manager for a leading manufacturer of electric washers and irons. His services will undoubtedly prove of considerable assistance to the dealer in his sales efforts.

Kits
Parts

Bremer Tully

Power Unit
Speaker

Radio Receivers



UXA Socket



BT "Lifetime" Condenser

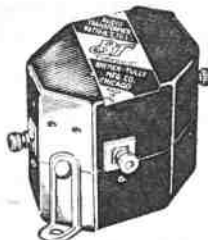

Euphonic Transformer

To the radio fan the B-T Trade-mark signifies "something better." Personal experience has taught him.

Back of this reputation is five years of service to the radio public — a period of time that has built experience and prestige.

Whether it is a B-T socket, condenser, transformer or any of the many other B-T products, you will find incorporated therein the latest advances in radio engineering.

Follow the recommendation of the radio fan! He knows!

BREMER-TULLY MFG. COMPANY

520 S. Canal Street

Chicago, Ill.

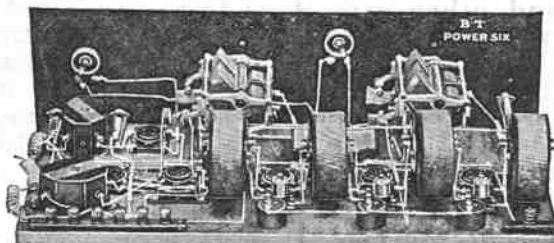

B-T Power Six — Furnished in Kit



VARIO DENSER

Tune quickly—adjust accurately—eliminate distracting noises—get correct tube oscillation—with X-L VARIO DENSERS in your circuit. Designers of all latest and best circuits specify and endorse them.

MODEL "N"—Slight turn obtains correct tube oscillation on all tuned radio frequency circuits. Neutrodyne, Roberts two tube, Brown-ing-Drake, McMurdo Silver's Knockout, etc. Capacity range 1.8 to 20 micro-microfarads. Price \$1.00



Model "G"

MODEL "G"—With grid clips obtains the proper grid capacity on Cockaday circuits, filter and intermediate frequency tuning in heterodyne and positive grid bias in all sets. Capacity range:

Model G-1 .00002 to .0001 M. F. D.
Model G-5 .0001 to .0005 M. F. D.
Model G-10 .0003 to .001 M. F. D.
Price \$1.50

X-L PUSH POST—Push it down with your thumb, insert wire, remove pressure and wire is firmly held. Vibrations will not loosen. Releases instantly. Price 15c



X-L Push Post

X-L PUSH POST PANEL—Permanently marked in white on black insulating panel. In box including soldering lugs, raising bushings and screws for mounting, etc. Price \$1.50



X-L Push Post Panel

Built the new LOFTIN-WHITE constant coupled radio frequency circuit. FREE wiring diagrams showing use of this and other popular circuits sent on request.

XL Radio Laboratories

2428 Lincoln Ave. Chicago, Ill.

COILS MATCHED

Radio frequency coils accurately matched for Infradynes and other sets. What a difference this makes. Only 35 cents per coil. Send them to Laboratory of "RADIO," Pacific Bldg., San Francisco. We also are in a position to purchase these coils for you.

RESISTANCE COUPLING

(Continued from page 30)

mfd. and fractional megohm leaks formerly in vogue. Condensers of this low capacity can be obtained in mica for approximately the same price as the 0.1 mfd. condensers in paper.

The objection to the small-condenser, large-leak arrangement is the possibility of "blocking" or choking up of the amplifier on strong signals. The new CX-340 tubes, however, have such characteristics as to minimize this tendency. As long as the leaks are of high quality and not more than the specified 2 megohms, difficulty due to blocking will not be encountered. The higher the resistance of the leak, the greater will be the gain or amplification per stage. Thus, aside from use of tubes with a higher mu than formerly, the gain of the amplifier is also still further increased by the use of higher resistance grid leaks.

The Tone Filter is a dual purpose device. In the plate circuit of the power tube are two currents, an alternating or audio frequency current, which when fed through the loud speaker, actuates the speaker mechanism, and a heavy direct current component, serving no useful purpose in the speaker. By separating the a. c. from the d. c., and only permitting the a. c. to pass through the speaker, the tone filter prevents the speaker from damage and improves the tone-quality. With the CX-112 or Ceco Type F tubes and even the CX-371 or Ceco J-71 when the plate voltage does not exceed 135 volts, the use of a tone filter is not essential.

The Voltage Stages

Dividing a resistance coupled amplifier into its two components, the voltage and the power stages, we are better able to consider the optimum design of each. The customary arrangement for the voltage stages is the use of two high mu tubes, with coupling units in cascade. While such a two stage voltage amplifier will give considerably more amplification than the single transformer and 201A tube that it replaces in the ordinary two stage transformer coupled amplifier, its use is recommended rather than a single stage in order to permit working with less radio amplification, resulting in less noise pick-up and less chance of distortion due to overloading the detector tube.

The input circuit of any audio frequency amplifier and particularly that of a resistance coupled audio frequency amplifier should contain an r. f. choke and by-pass condenser. The value of the r. f. choke will vary considerably with the type of set used with the amplifier. For instance, the ordinary tuned radio frequency type of receivers will require but a small choke, such as the Samson No. 80, whereas a superheterodyne, will generally require a large size choke.

In all cases the by-pass condenser should be at least .0005 mfd. and not over .001 mfd. in capacity.

By reference to Fig. 1, it will be seen that the use of a .006 mfd. coupling condenser with a 2 megohm grid resistor, as specified here for use with the new CX-340 high mu tube, will result in amplification which very closely approaches theoretical perfection.

As the plate impedance of the CX-340 under actual operating conditions is in the neighborhood of 150,000 ohms, plate coupling resistors of somewhat higher ohmic value must be used for the best quality. For this reason the .25 megohm units were selected.

Another important point is the filament voltage. Rheostats with noisy contacts and guess work settings (unless, of course, an expensive voltmeter is also employed), are no longer the only available means for controlling filament voltage. During the past year a new device, the filament "Equalizer" has been perfected which requires no adjustment but when connected in series with the filaments of five volt tubes tends to cause the ohmic resistance of the "tube + Equalizer" to so vary as the A battery becomes discharged as to keep the voltage across the filaments of the tubes well within the allowable limits for long life and efficient operation.

The Power Stage

Either CX-112 or Ceco F or CX-371 or Ceco J-71 may be used in the third or power stage. The 71 will give more undistorted power output than the 112 or F tube and is recommended in all cases except where extreme economy of plate current is essential. The ideal combination is the CX-371 or Ceco J-71 with a lamp B power supply unit such as the Mayolian, as under such conditions high voltage and current are just as available as lower voltage and current.

When used with the CX-112 or Ceco, Type F or the CX-371 or Ceco J-71 with plate voltages under 135, an output device, or tone-filter is not essential for the protection of the loud speaker.

As these specifications for coupling condenser, resistors and "non-motor-boating" filter circuit are followed in the first two stages, the use of a phase shifting grid impedance in the last or power stage is not required.

The various parts necessary for the construction of a resistance coupled amplifier embodying the essentials of good design just described may be mounted on a small piece of bakelite, or else upon a wood base-board. The parts required are few and inexpensive: 3 good sockets, 1 Lynch resistor kit, 7 Eby binding posts, 1 Samson r. f. choke, 1 Electrad .0005 mfd. condenser, 1 Electrad 1 mfd. condenser, 1 bakelite panel, 7"x12", 1 Mayolian tone filter (where 180 or more volts are employed on the plates), wire, switch, screw, etc.

VITROHM RESISTORS

—in power supply units

SILVER-MARSHALL
652 RESERVOIR B SUPPLY

Uses Vitrohm Resistor 507-64'

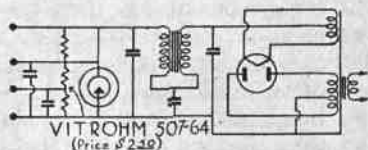

35 years of research and experience in the manufacture of resistors is incorporated in Vitrohms for radio.

There are available Vitrohms to give you noiseless, dependable service wherever resistance is indicated in a current or power supply circuit.

Vitrohms do not age or change in resistance value after use. Ten, twenty or thirty years of constant use under all conditions are every-day records of Vitrohms.

RAYTHEON A-B-C
350 m.a. CURRENT SUPPLY UNIT

Uses Vitrohm Resistor 507-62' and Vitrohm Rheostat 507-63

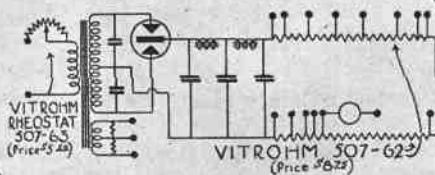

QRS A-B-C
400 m.a. CURRENT SUPPLY UNIT

Uses Vitrohm Resistor 507-62' and Vitrohm Rheostat 507-63

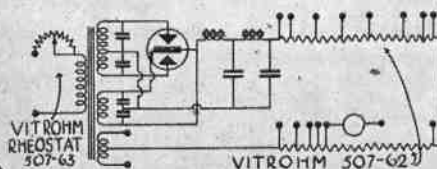

Vitrohms are "pre-aged" wire wound on porcelain tubes and protected by fused-on vitreous enamel for the permanent protection of resistance wire and terminals.

Per square inch of surface, Vitrohms have greater watt dissipation than any other resistor.

Send 15c for "How To Use Resistance in Radio." It contains many circuits of interest to all experimenters. Bulletin 507 describing Vitrohms for radio is sent without charge upon request.

* Approved by the Raytheon and QRS Laboratories.

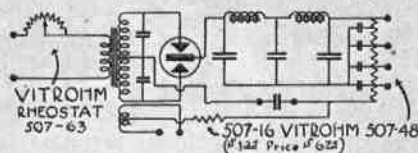

QRS and RAYTHEON
85 m.a. CURRENT SUPPLY UNIT

Uses Vitrohm Resistors 507-16' and 507-48'

Ward Leonard Electric Company

37-41 South Street

Mount Vernon, N. Y.

BRACH Storm King LIGHTNING ARRESTER



Over 2,000,000 Radios
are Now Protected
by Brach Arresters

Price
Only **\$1**

Like all Brach Arresters
the Storm King is backed
by our

**\$100 INSURANCE
GUARANTY**

Electrify your Radio
with the Wonderful

BRACH



CONTROLIT
THE HEART OF THE POWER PLANT

Over 75,000
used within
First Four Months

L.S. BRACH MFG. CO.



NEWARK, N. J. TORONTO, CAN.

MAHONEY'S HUNCH

(Continued from page 32)

where. Have any wires come for him?" The operator ran through his sheaf of messages received.

"Don't recall the name," he said. "We don't have much business here and I'm sure I'd remember the name. But you can look for yourself."

Mahoney ran through the messages. Inasmuch as "James Hanscomb" was purely a mythical character, it was not to be wondered at that he failed to find such a message. But he did find exactly what he wanted—a wire to Banjo Ed, unsigned and from Martinsville. He paused for a moment, memorizing the words. The operator misinterpreted his action.

"That's the famous Banjo Ed that sings over the radio," he explained. "He was in here just awhile ago . . . funny old coot."

"That so?" said Mahoney indifferently.

"Yeah—kicked because he says they jump him around from town to town. Guess the old boy likes to sleep in a haystack. . . ."

He chuckled. Mahoney nodded shortly.

"Guess there's no trace of my man," he said.

"Reckon not," said the operator. "I'll keep an eye out. Stayin' at the hotel?"

"Yes," said Mahoney. "You can get me there."

Back in his room at the hotel Mahoney jotted down the memorized words of the message. He knew quite a bit about codes and from the lack of signature he had no doubt in his own mind but that it was from Jake Dallas. Keller he figured might be a gang member, but he doubted this because Jake would not be fool enough to use the name. No—the whole message was a blind. Jake was no fool. Mahoney studied the words.

Finally he tried the first letters of the words—"Pinkton." Had he heard that name somewhere? He grunted, folded up the paper and went downstairs.

"Town named Pinkton around here anywhere?" he asked the clerk.

"Oh, yes," replied the clerk. "It's twenty miles or so west of us—the classiest little burg in the county—paved streets and all that kind of stuff. You bet—Pinkton's some city. We run a bus over there every four hours."

Mahoney swallowed. It had been a chance shot and it had hit the target.

"Thanks," he said. "Guess I'll go look it over. Pretty good town, eh?"

The clerk waxed enthusiastic. Pinkton it seemed was the county's major pride and joy. As he talked, Mahoney began to understand a lot of things, such as the meaning of Banjo Ed's presence at Owen—a safe place to receive a message, orders, instructions. Mahoney's

respect for Jake Dallas grew. No wonder he had been hard to catch when he worked out details to that degree. Mentally Mahoney began to gather up the threads.

Banjo Ed did his stuff in Owen that night and even Mahoney had to admit that he was all that had been claimed for him as an entertainer. He sang, told stories, did tricks with his banjo and for an hour kept the radio world within range of the station enthralled. But not for a moment was there any indication of an attempt to send a communication over the air. Mahoney listening in front of a radio store, turned back to his hotel, not the least disappointed. Things were working out as he had figured.

Late that night Mahoney suddenly checked out of Owen and made a fast run to Pinkton in his battered flivver. He signed his name on the Palace hotel blotter there and hunted up a breakfast. It was around noon that Banjo Ed came tramping into Pinkton and went directly to the broadcast station of the Chamber of Commerce, WXAI. There he talked for some time with the man in charge. Mahoney sitting on his spine in his flivver, saw them shake hands and Banjo Ed left and disappeared into a cafe. Mahoney climbed out of his car and went into the station.

"Who was that guy with the banjo?" he asked. "I've seen him somewheres."

"Oh, that was Banjo Ed—the famous Banjo Ed," said the man in charge. "He was coming through and offered to put on some stunts tonight. They say he's a knockout. I'll sure be glad to get him. It will be a big feature."

Mahoney thanked him and went out. He chuckled to himself at the thought of just how big a feature Banjo Ed was going to be to Pinkton.

This time, when Banjo Ed came out of the cafe, Mahoney "tailed" him closely, keeping a sharp eye on his movements. His suspicions verified themselves. Ed was after information concerning the First National bank. A question here and there, a study of the wires in and out, a squint at the uniformed policeman on the downtown beat—all done, adroitly, quickly, but all old stuff to a sleuth like Mahoney who knew his business. There was no doubt about it. Banjo Ed was lining up a "job."

Mahoney heard Banjo Ed's second concert at the hotel where he had registered. In keeping with its progressiveness, its one bell hop and initialed towels, the hotel had a first class radio set. People dropped in during the evening, picked out comfortable chairs in the lobby and listened. This particular night word of Banjo Ed's presence in town had gained wide circulation and the lobby was crowded. Mahoney found himself sitting beside a long, lanky red-headed youth who chewed gum rapidly

(Continued on page 78)

BROADCAST WEEKLY'S

New Log and Call Book

Just Off The Press

Revised June 15, 1927

Contains All The New Station Assignments

Features of this New Log and Call Book:

1. Handy size 4 x 6 inches.
2. Printed on Bond Paper.
3. Alphabetical list of all U. S. stations, giving the call letters, meters, kilocycles, location and space for three dial settings.
4. Alphabetical list of all U. S. stations, giving the call letters, meters, kilocycles, owner and location, and power.
5. Complete list of all U. S. stations arranged by meters and kilocycles.
6. Geographical list giving the location of stations by states and cities.
7. 48 pages are devoted to the above information. No advertising.

HERE ARE SAMPLE PAGES (approximately one-half size).

Log and Call Book 11

Call	Meters	Kcys	Location	Dial Settings
KWLC	541.8	1318	Des Moines, Iowa	
KWUC	543.8	1320	Ames, Iowa	
KWVO	571.6	1388	Brownsville, Texas	
KTYW	535	1310	Chicago, Illinois	
WAAD	541.1	1336	Cincinnati, Ohio	
WAAP	535.4	1310	Chicago, Illinois	
WAAM	545.8	1348	Newark, N. J.	
WAAT	538.8	1330	Jersey City, N. J.	
WAAX	574.8	1388	Omaha, Nebraska	
WABC	535.3	1322	Hempstead Hill, N.Y.	
WABF	535.4	1324	Pringsboro, N.C.	
WABH	534.4	1318	Bangor, Maine	
WABO	532.4	1320	Rochester, N. Y.	
WABQ	535.6	1318	Philadelphia, Pa.	
WABR	536.2	1324	Toledo, Ohio	
WABT	537.8	1334	Waco, Texas	
WABU	537.8	1334	Waco, Texas	
WABV	537.8	1334	Waco, Texas	
WABW	537.8	1334	Waco, Texas	
WABX	537.8	1334	Waco, Texas	
WABY	537.8	1334	Waco, Texas	
WABZ	537.8	1334	Waco, Texas	
WACA	537.8	1334	Waco, Texas	
WACB	537.8	1334	Waco, Texas	
WACD	537.8	1334	Waco, Texas	
WACE	537.8	1334	Waco, Texas	
WACF	537.8	1334	Waco, Texas	
WACG	537.8	1334	Waco, Texas	
WACH	537.8	1334	Waco, Texas	
WACI	537.8	1334	Waco, Texas	
WACJ	537.8	1334	Waco, Texas	
WACK	537.8	1334	Waco, Texas	
WACL	537.8	1334	Waco, Texas	
WACM	537.8	1334	Waco, Texas	
WACN	537.8	1334	Waco, Texas	
WACO	537.8	1334	Waco, Texas	
WACP	537.8	1334	Waco, Texas	
WACQ	537.8	1334	Waco, Texas	
WACR	537.8	1334	Waco, Texas	
WACS	537.8	1334	Waco, Texas	
WACT	537.8	1334	Waco, Texas	
WACU	537.8	1334	Waco, Texas	
WACV	537.8	1334	Waco, Texas	
WACW	537.8	1334	Waco, Texas	
WACX	537.8	1334	Waco, Texas	
WACY	537.8	1334	Waco, Texas	
WACZ	537.8	1334	Waco, Texas	

Log and Call Book 28

Call	Meters	Kcys	Owner and Location	Power
KULR	543.8	1320	Seattle, Washington	10
KULS	543.8	1320	Chicago, Illinois	10
KULM	543.8	1320	Chicago, Illinois	10
KULN	543.8	1320	Chicago, Illinois	10
KULO	543.8	1320	Chicago, Illinois	10
KULP	543.8	1320	Chicago, Illinois	10
KULQ	543.8	1320	Chicago, Illinois	10
KULR	543.8	1320	Chicago, Illinois	10
KULS	543.8	1320	Chicago, Illinois	10
KULM	543.8	1320	Chicago, Illinois	10
KULN	543.8	1320	Chicago, Illinois	10
KULO	543.8	1320	Chicago, Illinois	10
KULP	543.8	1320	Chicago, Illinois	10
KULQ	543.8	1320	Chicago, Illinois	10
KULR	543.8	1320	Chicago, Illinois	10
KULS	543.8	1320	Chicago, Illinois	10
KULM	543.8	1320	Chicago, Illinois	10
KULN	543.8	1320	Chicago, Illinois	10
KULO	543.8	1320	Chicago, Illinois	10
KULP	543.8	1320	Chicago, Illinois	10
KULQ	543.8	1320	Chicago, Illinois	10
KULR	543.8	1320	Chicago, Illinois	10
KULS	543.8	1320	Chicago, Illinois	10
KULM	543.8	1320	Chicago, Illinois	10
KULN	543.8	1320	Chicago, Illinois	10
KULO	543.8	1320	Chicago, Illinois	10
KULP	543.8	1320	Chicago, Illinois	10
KULQ	543.8	1320	Chicago, Illinois	10

Log and Call Book 35

Call	Meters	Kcys	Owner and Location	Power
KELB	536.8	1320	Chicago, Illinois	10
KELC	536.8	1320	Chicago, Illinois	10
KELD	536.8	1320	Chicago, Illinois	10
KELE	536.8	1320	Chicago, Illinois	10
KELF	536.8	1320	Chicago, Illinois	10
KELG	536.8	1320	Chicago, Illinois	10
KELH	536.8	1320	Chicago, Illinois	10
KELI	536.8	1320	Chicago, Illinois	10
KELJ	536.8	1320	Chicago, Illinois	10
KELK	536.8	1320	Chicago, Illinois	10
KELL	536.8	1320	Chicago, Illinois	10
KELM	536.8	1320	Chicago, Illinois	10
KELN	536.8	1320	Chicago, Illinois	10
KELO	536.8	1320	Chicago, Illinois	10
KELP	536.8	1320	Chicago, Illinois	10
KELQ	536.8	1320	Chicago, Illinois	10
KELR	536.8	1320	Chicago, Illinois	10
KELS	536.8	1320	Chicago, Illinois	10
KELM	536.8	1320	Chicago, Illinois	10
KELN	536.8	1320	Chicago, Illinois	10
KELO	536.8	1320	Chicago, Illinois	10
KELP	536.8	1320	Chicago, Illinois	10
KELQ	536.8	1320	Chicago, Illinois	10
KELR	536.8	1320	Chicago, Illinois	10
KELS	536.8	1320	Chicago, Illinois	10
KELM	536.8	1320	Chicago, Illinois	10
KELN	536.8	1320	Chicago, Illinois	10
KELO	536.8	1320	Chicago, Illinois	10
KELP	536.8	1320	Chicago, Illinois	10
KELQ	536.8	1320	Chicago, Illinois	10

Log and Call Book 41

Call	Meters	Kcys	Owner and Location	Power
KELB	536.8	1320	Chicago, Illinois	10
KELC	536.8	1320	Chicago, Illinois	10
KELD	536.8	1320	Chicago, Illinois	10
KELE	536.8	1320	Chicago, Illinois	10
KELF	536.8	1320	Chicago, Illinois	10
KELG	536.8	1320	Chicago, Illinois	10
KELH	536.8	1320	Chicago, Illinois	10
KELI	536.8	1320	Chicago, Illinois	10
KELJ	536.8	1320	Chicago, Illinois	10
KELK	536.8	1320	Chicago, Illinois	10
KELL	536.8	1320	Chicago, Illinois	10
KELM	536.8	1320	Chicago, Illinois	10
KELN	536.8	1320	Chicago, Illinois	10
KELO	536.8	1320	Chicago, Illinois	10
KELP	536.8	1320	Chicago, Illinois	10
KELQ	536.8	1320	Chicago, Illinois	10
KELR	536.8	1320	Chicago, Illinois	10
KELS	536.8	1320	Chicago, Illinois	10
KELM	536.8	1320	Chicago, Illinois	10
KELN	536.8	1320	Chicago, Illinois	10
KELO	536.8	1320	Chicago, Illinois	10
KELP	536.8	1320	Chicago, Illinois	10
KELQ	536.8	1320	Chicago, Illinois	10
KELR	536.8	1320	Chicago, Illinois	10
KELS	536.8	1320	Chicago, Illinois	10
KELM	536.8	1320	Chicago, Illinois	10
KELN	536.8	1320	Chicago, Illinois	10
KELO	536.8	1320	Chicago, Illinois	10
KELP	536.8	1320	Chicago, Illinois	10
KELQ	536.8	1320	Chicago, Illinois	10

USE THE COUPON

Broadcast Weekly Publishing Co., Inc.,
416 Pacific Building,
San Francisco, Calif.

Gentlemen: Enclosed herewith is 25 cents for which please send your new Call & Log Book.

Name.....

Address.....

City.....

State.....

SM

Specified for the Infradyne



The remarkable tone quality of the new 1927 Infradyne depends wholly upon S-M 220 Audio transformers. Infradyne engineers spent months in laboratory research perfecting the selectivity and sensitivity of the new set to an uncanny degree. Nevertheless they knew that their success would turn to failure if they failed to use the very finest audio amplifier to preserve and enhance the Infradyne's tone quality.

S-M 220 transformers were specified and used in all models, for Infradyne engineers knew from their laboratory records that S-M audios were not only the finest, but were ideally suited to the new Infradyne. Vital factors were the 5,000 cycle cut-off of the 220's which helps to render Infradyne reception on the weakest signals free from noise and hiss.

Laboratory tests upon end have proven the unquestioned superiority of S-M 220's for audio amplification. Designers of new 1927 circuits know this, and in almost every set where no expense is to be spared in obtaining realistic reproduction, 220's will be found.

The new Infradyne, the Aerodyne "Four," "Five" and "Six" circuits, the new Benjamin receiver, Citizens Super, Radio News Super, Radio Broadcast Improved Silver Super, and many others not yet announced depend on 220's.

Many broadcast stations know the worth of S-M audio transformers and use them in their studio and line amplifiers—WCAE, WEBH, WCFL, WBBM, WTAQ, KGDJ, WLBF, for instance, while WCFL (Federation of Labor station) checks all transmission with monitoring equipment employing 220's and 221's—their test for perfect transmission.

No matter what set you build, it will give more realistic quality with S-M audio transformers. If most 1927 circuit designers use them, and experienced broadcasters depend on them, that's proof you can't find anything better!

For A. C. Tubes

For the new A. C. tubes, Silver-Marshall offers a new Universal filament transformer, a new 5 prong UY and CY socket, and other power equipment.

Type 325 Filament Lighting Transformer, for operation from 105 to 120 volts, 60 cycle mains, is provided with three independent low voltage secondaries. The first will operate up to twelve UX-226 or CX-326 or equivalent tubes (1.5 volts maximum). The second will light six to eight UY-227 or CY-327 or equivalent heater tubes (2.5 volts maximum). The third winding (with center-tap) will operate three 210 or equivalent 7.5 volt tubes, or six 112, 171 or equivalent 5 volt tubes. Price, in uniform S-M Shielded case, with cord and plug, \$8.00.

Type 512 Moulded Bakelite Socket will accept all new 5 prong tubes such as UY-227, CY-327 or equivalent tubes. Type 512 has $\frac{1}{8}$ in. greater diameter than 511 standard socket, but because of same mounting hole centers, may replace 511 sockets in present sets where desired. Price, 75c.

Type 330 Power Transformer, provided with one 600 volt center tapped secondary and 7.5 volt filament winding is ideal for new UX-281 and CX-381 or equivalent high power rectifiers, for it will furnish 110 milliamperes or more in continuous operation. It is also suited to new CX-280 and CX-380 medium power full wave rectifiers, (or Q.R.S. 85 M.A. or equivalent gas rectifiers) and will furnish 300 volts to each plate of these or similar tubes, at 125 milliamperes in continuous duty. Type 329 transformer with two 200 volt secondaries, is normally recommended for these tubes for 220 volt output. Price \$9.00 each.

Type 331 Unichoke will provide excellent filtration up to 125 M.A. at from 200 to 600 volts using but 7 M.F. of filter capacity because of its selective tuned circuit which completely eliminates the fundamental 120 cycle hum in rectifier output voltages. Price \$8.00.

Type 230 and 231 Push-Pull Input and Output Transformers are the only means of attaining truly realistic reproduction at high volume, using 112, 171 or 210 tubes. Price \$10.00 each.



SM

Realism in Reproduction

In June 1926, over a year ago, Silver-Marshall, Inc., cast a bomb-shell into the field of audio reproduction with the now famous 220 audio and 221 output transformers—today the largest selling and most popular high-grade audio transformers.

S-M engineers had designed 220's and 221's in direct contradiction to the general engineering dictum that "perfect" audio amplifiers would give "faithful" amplification which would result in perfect quality of broadcast reception. Their analysis had disproved this belief—they knew that 220's, designed with a rising low frequency characteristic and 5000 cycle cut-off would, in an ordinary receiver, with ordinary loud speakers and broadcast transmission, give truly realistic sound recreation. Today, the S-M ideal is substituted by advanced engineers for the old one of theoretically "perfect" this and "faithful" this or that—and realism of reproduction is demanded.

And exactly as S-M engineering lead a year ago, so it leads again, with the new Unipacs, power amplifiers that added to any set will recreate broadcast programs with astounding realism.

Why? Simply because the larger models, having many times the undistorted power capacity of other power-packs, can give fullness, body and brilliancy to a reproduced program utterly impossible with ordinary amplifiers.

That's why a Unipac is recommended for Infradyne owners who want the most—that's why editors and authorities hearing it for the first time are positively amazed. Mail in your name and get the whole story—it will tell you how to really improve your present set or the one you're going to build.

112 K C Long Wave Time Signal Amplifier

Type 440 amplifier designed for reception of standard NAA time signals by jewelers and other observers, is a specially sharply tuned and extremely sensitive unit. The copper housing contains three individually shielded, tuned R. F. amplifier stages and a detector with all necessary leads brought out.

Each unit is positively and accurately matched in the S-M laboratories to exactly 112 kilocycles. The 440 is the only complete, pre-tuned long wave amplifier available, and is a far more sensitive and sharply tuned amplifier than could be built from individual transformers.

Send for data. Price \$35.00.

SILVER-MARSHALL, INC.

852 W. JACKSON BLVD.
CHICAGO, U. S. A.

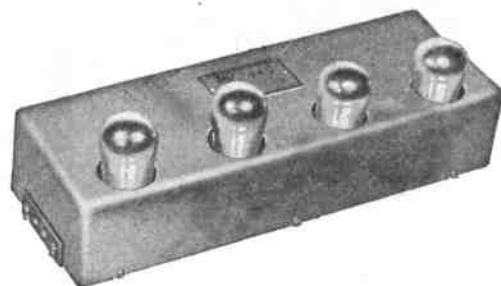
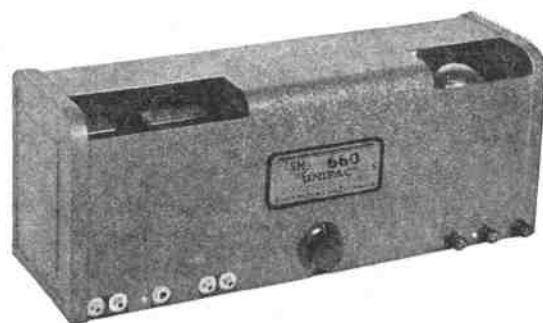



Automatic

Snap the filament switch on your set and the trickle charger is automatically disconnected and the B-eliminator connected to the house current—that is, if you have a Jewell A-B Relay. Your set is ready to tune in without the bother of changing the several connections by hand.

When the filament switch is snapped off, a reverse of the above operation takes place.

The Jewell A-B Relay is very convenient.

Write us for special circular No. 1023.

Jewell Electrical Instrument Company

1650 WALNUT STREET, CHICAGO

"27 Years Making Good Instruments"

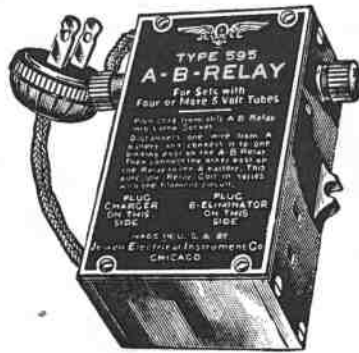

A-B Relay

The A-B Relay is very compact and will not interfere with normal operation of any set. It consists of a low resistance magnet placed in series with the filament and A-battery and actuating special contacts.

(Continued from page 74)

and regarded the assembled gathering with a speculative eye. Mahoney sensed instantly that he was more or less of a stranger to Pinkton like himself.

"Live here?" he asked casually, while they waited for WXAI to come on the air.

The red-headed one grinned.

"Not me," he said. "M' folks do. I come up from the Gulf and visit 'em once in a while. I'm a ship op . . . at sea most of the time. But I get a kick out of this—watchin' these hicks and their radio. Here I work with it all the time and yet when I hear they got a set here—I breeze over. Ain't it a kick? In the blood I guess."

Mahoney laughed. He thoroughly understood the feeling. In his own case, it was the red and green lights of a railroad yard . . .

WXAI cut in at that moment and the program came on—the usual small town program of musical and vocal numbers. Then the announcer broke in to say that he had a surprise, and introduced Banjo Ed. The entertainer was in good form that night and he put on a good show.

"Say—that bimbo's good," whispered the red-headed youth in Mahoney's ear. "He's got a line I ain't. . . ."

He broke off and a peculiar expression came over his face. He stopped chewing and scowled at the radio set. Finally he turned and stared at Mahoney. The latter was conscious of a rising excitement.

"What's the matter?" he asked quickly.

"Well, I'm damned," said the red-headed one.

He grabbed for his pockets and brought out an envelope and a pencil. On the back of the envelope he began to write rapidly. Mahoney read over his shoulder.

" . . . one watchman . . . six harness . . . no rattle . . . dead after nine . . . fone office across street . . . Jensen vaults . . . about sixty grand. . . ."

The red-headed operator swung on Mahoney.

(Continued on page 80)

Metal Cans for the new ABC Eliminator

Sheet steel cans, with steel baseplate, exactly as specified by G. M. Best in this issue, shipped direct from the factory. Cans are of best grade 20 gauge steel, riveted at all joints, and finished in handsome baked enamel. Baseplate has flanged edges, so that wires can be run underneath. Ventilating holes in sides and lid provide adequate protection against overheating of parts. Ideal for any type of ABC eliminator, and absolutely fireproof.

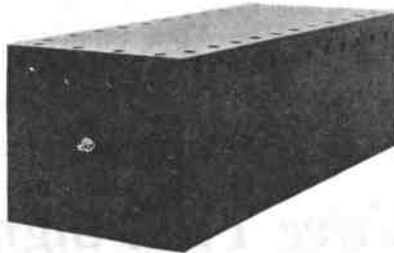

Price \$5.00, f.o.b. factory at Oakland

WESTERN TRANSFORMER COMPANY

618 EAST 11th STREET

OAKLAND, CALIF.

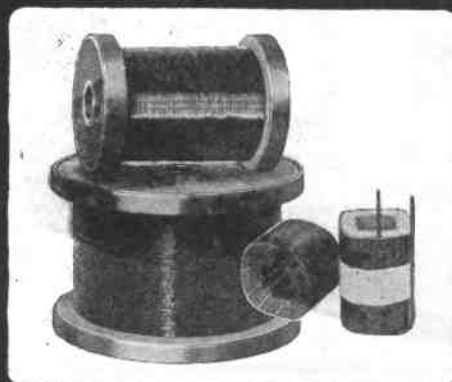

Pacific Coast Headquarters for

MAGNET WIRE and WINDINGS A. S. LINDSTROM CO.

324 N. San Pedro St.
Los Angeles

274 Brannan St.
San Francisco

95 Connecticut St.
Seattle

221 S. W. Temple
Salt Lake City

146 1/2 N. 10th St.
Portland

DUDLO MANUFACTURING CORPORATION FT. WAYNE, IND.

They

stand the surges

PARVOLT WOUND CONDENSERS

Are specified most frequently in circuits where service is hard and only a good condenser can stand up.

Use the proper Parvolt Wound Condensers in the filter circuits of current supply units and know that all condenser problems are completely eliminated.

Parvolt Wound Condensers are made for three maximum service voltages:

- Type A— 400 V. d. c. con. duty
- Type B— 800 " " " "
- Type C—1000 " " " "

THEY STAND THE SURGES

Made and guaranteed by
ACME WIRE COMPANY
NEW HAVEN, CONNECTICUT

SARGENT'S NEW INFRADYNE MANUAL

Is now ready for
Immediate Delivery

Order your copy now
by sending 25c in coin or
stamps to

"RADIO"

433 Pacific Bldg., San Francisco

LET US BRING YOUR



UP-TO-DATE!

WE specialize on the DeLux Model of the Sargent-Raymont Infradynes. This receiver is acknowledged to be the outstanding set of the 1927 season. Our own experience with the set convinces us that it is destined to lead the radio field for many years to come. In our test laboratory we have received two Japanese Stations—JOAK and JOBK; 2BL in Sydney, Australia, as well as PWX, CZE, WBZ, WEAN, WNYC, WRNY, WGY and WJZ. Selectivity is razor-edged.

We guarantee to rebuild or service any Infradyne and make it the equal of our laboratory model. We have installed special laboratory test instruments to do this. Charges are reasonable. Send in your set and when you get it back all parts will be matched. It will be tested on DISTANCE and DIALS LOGGED for direct reading in wavelength.

[NOTE When shipping the set, remove it from the cabinet and put in heavy carton or wooden box. If shipped in a box, screw the baseboard to the inside of the box. Ship by prepaid express.]

INFRADYNE KITS

Containing only specified parts, each part laboratory-tested and matched to the others. Full instructions accompany each Kit. SARGENT-RAYMENT KIT, Complete

\$118.00

INFRADYNE BLUE PRINTS—\$1.00 per set, postpaid

RADIO SERVICE COMPANY

357 TWELFTH STREET, OAKLAND, CALIFORNIA

DIRECT FROM FACTORY TO YOU

Western "B" Power Unit

Ample power for
171 tube.

Two voltage
controls.

No hum.

No distortion.

Full wave recti-
fication.



180
VOLTS

\$18.50

Why be troubled with batteries when you can now buy a guaranteed Western "B" Power Unit for less than half the price of others.

The Western "B" Power Unit is a quality product throughout, made of the finest materials, absolutely guaranteed to give complete satisfaction or money refunded.

OPERATES ANY SET FROM THE LIGHT SOCKET.
LIKE HAVING NEW BATTERIES EVERY NIGHT.

Mail the Coupon Today

Shipped same day order received.

Endorsed by the Calibration Laboratory of RADIO Magazine for use with sets from one to ten tubes.

ASHWORTH & GALLOP,
5845 E. Broadway, Los Angeles,

Gentlemen:—Please send me at once one Western "B" Power Unit. If after seven days' trial it is not satisfactory, I will return it and you will refund my money.

Payment Enclosed, \$18.50.
 Send C. O. D.

Name _____
Address _____
City _____ State _____

Tell them that you saw it in RADIO

Hoyt

RADIO SERVICE METERS and EQUIPMENT

A Complete Line for Manufacturers, Dealers, Consumers

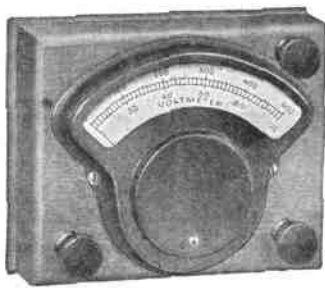

B ELIMINATOR VOLTMETER

A new sensitive voltmeter, for regular dealers' service work as well as for laboratory and precision measurements. Resistance 1,000 ohms per volt. Provided with two scales—0-100 volts and 0-500 volts, covering the entire range of ordinary B-Eliminator and Power-Amplifier work.

Prices:
HOYT Standard B-Eliminator Voltmeter, 0-100 and 0-500 volts, \$28.00.
Supplied on special order with additional scale, either: 0-10 volts or 0-100 ma. at \$32.50.

Send for Price List P-6

BURTON-ROGERS COMPANY
BOSTON SOLE SELLING AGENTS MASS.



New HOYT SERVICE SET TESTER

This new HOYT instrument makes all continuity tests on any Radio set and gives instant readings of the filament and plate voltages on any tube, the plate current, and a test of grid connections. It may be used in addition as an accurate tube tester.

Equipped with precision, moving coil voltmeter, resistance, 1,000 ohms per volt, with knife-edge pointer highly damped, and 3-inch hand calibrated, 3-range scale—0-10 and 0-500 volts, and 0-25 M.A. Equipped also with external binding posts, and rubber covered leads with prods, for external tests of batteries and B-Eliminators. Dimensions: 9 by 7 by 3 1/2 in. Cased in finished hardwood box with cover and leather carrying handle.

Price, complete with Adaptors.....\$60.00

A COMPLETE LINE

HOYT makes a complete line of meters for every Radio use—Service Set Tester, B-Eliminator Voltmeter, Direct Reading Tube Tester, Counter Tube Tester, Miniature Galvanometer; Pocket Meters in all types, for battery testing; Radio Set Panel and Tip-in Meters, for filament plate voltage measurements; Milliammeters, Hot Wire Ammeters and A. C. Instruments from 2-inch in diameter up.

Send for booklet
"HOYT METERS FOR RADIO."

See Us
At
Booth 14



R M A
Show
Chicago

(Continued from page 78)

"Say—what do you know about that?" he demanded excitedly. "Well—that's a new one on me. . . ."

Mahoney sank his fingers in the other's arm.

"Where did you get that stuff you wrote there?" he demanded.

"Banjo Ed," said the other. "He's doin' it on his banjo—you know on the strings. It sounds like he is playing an accompaniment but he ain't . . . he's shootin' Continental code. It's a bum fist but I can make it . . . well, what do you make of that?"

Banjo Ed at the moment was singing a low crooning southern melody—such a one as calls for an irregular, strummed accompaniment which might mean anything or nothing—the strings just touched now and then.

"He cuts in on the Continental about every two or three measures and he'll tum-tum along and it don't mean anything. Can you beat it?"

Mahoney jerked the youth's sleeve.

"Come with me and keep your mouth shut," he commanded.

There was a tone of authority in his voice that caused the other to stare at him in amazement. But he rose immediately and followed the detective into a quiet part of the lobby. There Mahoney cupped a badge in his hand so the other could see it.

"Come with me," he said and led the way to the elevator.

Nothing was spoken until they reached Mahoney's room. There the detective locked the door and turned on the red-headed one.

"Were you in the world war?" he asked.

"Sure was—army intelligence, signal corps. . . ."

"That's enough for me," snapped Mahoney. "I'm Jerry Mahoney of the Bankers' Association. I'm after the Dallas gang. You know who they are. I want your help. Are you with me?"

The red-headed one hitched up his belt, and shifted his gun.

"I'll say I am," he said. "I'm James Henry McNulty Wallace, otherwise Bud to my friends. What's the dope?"

"Well, Bud—do you want some excitement?" asked Mahoney.

The other's face lighted.

"Fellab," he said. "I'm famined for action."

Mahoney handed him a cigar and kicked a chair within reach.

"I'll translate that stuff you copied," he said. "One watchman you can get. Six harness means six uniformed cops. No rattle means no burglar alarm. Jensen vaults are a special type of vault that are easy to get into. Sixty grand is sixty thousand dollars. . . ."

"A stickup?" broke in Bud Wallace.

(Continued on page 86)

Wonderful Bargain

at \$2.90

Here's a beautiful cabinet at a remarkable price made possible only by our tremendous production. It is quality you can't match at twice the price. The Cabinet is made of selected hardwood with three coats of lacquer, all rubbed down to a rich, lustrous piano finish. Two nickel plated hinges. No Increased Price even for Larger Sizes. A real bargain for the amateur set builder.



Piedmont

Dimensions

7" x 18" x 10" Deep
7" x 21" x 10" Deep
7" x 24" x 10" Deep
7" x 26" x 10" Deep

Your Choice at \$2.90 Ea.

f.o.b. Hickory

Cash with Order.

No C. O. D.'s

At this special price.

12 hour service factory to you.

Southern Toy Co. Inc.
Manufacturers Hickory N.C.

METERS

WE REPAIR THEM REGARDLESS OF MAKE

Voltmeters, Ammeters, Wattmeters

Send Them To Our Laboratory



219-221-223 Natoma St. San Francisco

The Improved Aero Universal Coil

Aero Universal Tuned Radio Frequency Kit

Kit of 4 Coils (for Improved Aero-Dyne)

Kit consists of 4 twice-matched units; one AERO Antenna Inductance with variable primary and three AERO Universal Radio Frequency Transformers. Adaptable to 201A, 199, 112, also the new 240 tubes, and the new A. C. tubes. Tuning range—below 200 to above 550 meters, for use with .0005 mfd. (500 mmf) Condenser.

A kit that will make any circuit better in selectivity, tone and range. Will eliminate losses and give the greatest receiving efficiency. Each Kit carefully matched at both ends of the broadcast range before packing.

For .0005 Condenser, Code No. U-16. List price.....\$16.00

NOTE—The Improved Aero-Dyne Circuit comprehends the use of .0005 mfd. (500 mmf) condensers. We urge steadfastness to these recommendations. If, however, a like kit is desired for other purposes, to use .00085 condensers, the same may be procured by ordering Code No. U-168.

For .00035 Condenser, Code No. U-163. List price.....\$16.00



Code No. U-16

Aero Universal Tuned Radio Frequency Kit

Kit of 3 Coils (for Aero-Seven)

Consists of 3 twice-matched units; three AERO Universal Radio Frequency Transformers. Coils are wound on bakelite skeleton forms, assuring 95 per cent air dielectric. Tuning range from below 200 to above 550 meters. Uses .0005 mfd. (500 mmf) Condenser.

Adaptable to 201A, 199, 112, also the new 240 tubes and the new A. C. tubes. Each Kit carefully matched at both ends of the broadcast range before packing.

For .0005 Condenser, Code No. U-12. List price, Kit of 3.....\$12.00

NOTE—The Aero-Seven Circuit comprehends the use of .0005 mfd. (500 mmf) condensers ganged. We urge steadfastness to these recommendations. If, however, a like kit is desired for other purposes, to use .00085 condensers, the same may be procured by ordering Code No. U-123.

For .00035 Condenser, Code No. U-123. List price, Kit of 3.....\$12.00

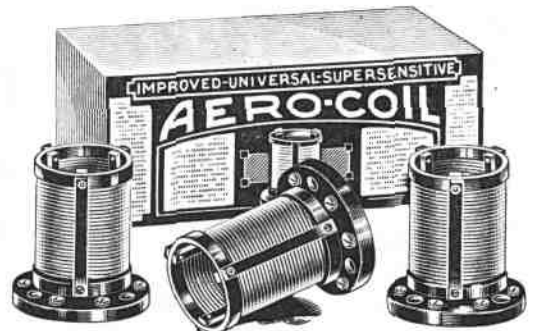

Code No. U-12

Aero Universal 3-Circuit Tuner

In the form of a 3-circuit tuner, this AERO Coil will improve any circuit.

With this 3-circuit tuner, the efficiency of the 3-circuit regenerative set is greatly increased because of the low-loss characteristics of the AERO Universal Coil.

For .0005 Condenser, Code No. U-55. List price.....\$5.50

For .00035 Condenser, Code No. U-553. List price..... 5.50

Adaptable only to 201A, 199, 112 or the new A. C. tube.

Equipped with variable primary for governing the selectivity of the Circuit. For use with a .0005 mfd. (500 mmf) Condenser.

Each Kit carefully matched before packing.



Code No. U-55

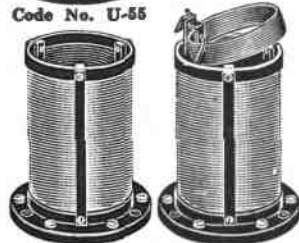

Code No. U-95

Aero Radio Frequency Regenerative Kit

An indispensable kit consisting of an AERO Universal Radio Frequency Transformer and an AERO Universal 3-circuit Tuner.

Any set built along these lines can be made much more efficient by substituting this set of

AERO Universal Coils. Uses two .0005 mfd. (500 mmf) condensers.

Uses only 201A, 112, and 199 tubes and the new A. C. tubes.

For .0005 Condenser. Code No. U-95. List price.....\$9.50

For .00085 Condenser. Code No. U-953. List price..... 9.50

Aero Universal Antenna Coupler

A highly efficient low-loss antenna coupler, with variable primary. Incorporates the famous AERO Universal Coil principles. Uses a .0005 mfd. (500 mmf) condenser.

Adaptable to 201-A, 199, 112, also the new 240 tubes, and the new A. C. tubes.

For .0005 Condenser. Code No. U-96. List price.....\$4.50

For .00085 Condenser. Code No. U-963. List price..... 4.50



Code No. U-96

NOTICE

Aero Universal Coils are also furnished for use with .00085 condensers or .00087 condensers. In our kits, however, we recommend coils for use with the standard .0005 condensers.

Demands for inductances to tune with .0005 and .00085 condensers have indicated two different channels of popularity. To avoid confusion, have your orders carefully made out. The distinguishing mark is in the Code Number. You will observe that in the Aero Universal line the figure "Three" appears at the end in all code numbers where coils to tune with .00035 or .00087 condensers are desired. Where there is a failure on the order to stipulate code numbers, coils to tune with .0005 condensers will be shipped.

Aero Universal Wave Trap Unit



Code No. U-4

This makes an excellent wave trap due to the low distributive capacity and the low high frequency resistance of the AERO Universal Coil. Such a wave trap will be a tremendous aid to you in the elimination of bothersome interference.

Can also be used to make any crystal set more efficient, as this is the world's ideal coil for increasing the power and range of a crystal receiver which must depend entirely upon conserving the energy collected by the antenna. Uses .0005 mfd. (500 mmf) condenser.

Adaptable to 201A, 199, 112, also the new 240 tube, and the new A. C. tubes.

For .0005 Condensers. Code No. U-4. List price.....\$4.00

For .00035 Condensers. Code No. U-43. List price..... 4.00

Illustration at right shows the widely advertised Radio News Wave Trap using Coil AX 45, Aero Universal Coil, Code No. U-963, may be used at same price and is in compliance with all other essentials.

Choke Coils

Three new, highly efficient choke coils are to be found in the Aero line, each designed to serve a specific need, rather than relying upon one of general construction to give an average service in all fields. One is the Aero Choke coil for Tuned Radio frequency purposes; another is of special winding to care for very high frequencies in the Short Waves, and still another is designed for transmitter purposes on Short Waves. The list price on each is \$1.50.



Radio News Wave Trap

1768-1772 Wilson Ave. - **AERO PRODUCTS, Inc.** - Chicago, Ill.

Tell them that you saw it in RADIO

Let's be
SENSIBLE
about this
SOCKET
POWER
question
!

WE'LL all get a lot more satisfaction out of radio & set owners, dealers and manufacturers & when we stop expecting the impossible.

Based purely on research and experience, MAR-CO has come to the conclusion that ...

—there is no such thing as a
“good, cheap eliminator”...

either “A” or “BC”. And the readers of “RADIO” know that dealers, as well as manufacturers, have already spent plenty of money to find that out.

But MAR-CO also knows that set owners everywhere demand more *permanent*, more *dependable* power sources than they have had in the past.

In line with this viewpoint MAR-CO is announcing three A. C. power devices:

- a socket “A” power, using Raytheon cartridges, at \$60.
- a socket “BC” power, giving *all* the needed *exact* voltages, at \$55.
- a *DRY* storage battery charger and power control, at \$12.50, with *renewable* cartridge rectifier.

And as the maker of both eliminators and chargers, MAR-CO's advice on their proper use is entirely unbiased ...

To the set owner who wants *complete* freedom from batteries, *permanent* unvarying power & MAR-CO offers “A” and “BC” socket powers.

These two devices are splendidly made & purposely designed to give the *exact* output desired under varying conditions. Handsome and rugged in appearance, they have the reserve strength to merit your whole-hearted confidence. With each one, MAR-CO gives a year's guarantee.

MAR·CO

*O*F COURSE, the man who wants such dependable quality in socket-powers must be prepared to *pay* what *good* equipment costs.

But the point is this . . .

Without charging a *quality* price, MAR-CO knows no way of building a socket-power that can carry a MAR-CO guarantee.

And to the set owner who does not want to spend the price of *good* "eliminators", MAR-CO's advice is this . . .

Don't buy ANY eliminator. Instead, rely upon heavy-duty dry cells for "BC" supply, and upon a storage battery and well-designed charger for "A" supply. With the right charger, this combination is a thoroughly satisfactory source of enjoyable reception, at low cost.

And MAR CO also offers the *right* charger. Small and compact, it is entirely free from liquids of any sort, tubes, or noise. It also provides complete automatic "A, B and C" power control. The rectifying element is a "Dry Rex" cartridge, guaranteed for 2000 hours, and then replacable at slight cost. This, then, is MAR-CO's advice, a stand which can only receive commendation from engineering authorities . . .

Either spend enough for *good* socket-powers, or else rely on batteries and a MAR-CO DRY charger.

To Dealers

who share this sensible view of the power situation, MAR-CO extends hearty cooperation. If you want to build *your* business on permanent customer satisfaction . . . if you want to sell equipment that makes good on your promises . . . if you want *profits* & not grief . . . then build with MAR-CO. Get the complete details of this worthy socket-power line. Write today to Martin-Copeland Company, Providence, Rhode Island.

MAR·CO



HIGHLIGHTS

There is no such thing as a "good cheap eliminator."



As the maker of both socket-powers and chargers, MAR-CO's advice on their proper use is entirely unbiased.



Better to put off buying ANY socket-powers than to buy *poor* ones.



The set-owner who is prepared to *pay* what *good* equipment costs & & will select MAR-CO Socket "A" power and Socket "BC" power.



The set-owner who wants enjoyable reception at *low* cost & will best rely on batteries and a MAR-CO DRY charger.



This is the *sensible* attitude toward socket-power & it leads to enjoyable reception instead of grief.



MAR-CO

radio power supply units

SOCKET "A" POWER
SOCKET "BC" POWER

DRY CHARGER
with renewable cartridge rectifier

SANGAMO

MICA CONDENSERS



CAPACITIES and PRICES

0.00004	0.001	} 50c.
0.00005	0.0012	
0.00006	0.0015	} 60c.
0.00007	0.00175	
0.00008	0.002	} 70c.
0.0001	0.0025	
0.00012	0.003	} 85c.
0.00015	0.0035	
0.000175	0.004	} 90c.
0.0002	0.005	
0.00025	0.006	} 95c.
0.0003	0.007	
0.00035	0.0075	} \$1.00
0.0004	0.008	
0.0005	0.01	} 1.15
0.0006	0.012	
0.0007	0.015	} 1.20
0.0008	0.015	

With Resistor clips, 10c extra



We Recommend Parvoit Wound Condensers

SANGAMO ELECTRIC COMPANY

SPRINGFIELD, ILLINOIS

5336-1

Intermediate Transformers MATCHED

Let Gerald Best and D. B. McGown match and "peak" the intermediate transformers for your super. Proper fixed condensers will be attached. This entire service for \$2.50. Condensers extra. Laboratory of "RADIO," San Francisco

Make Any Good Receiver

CEC BETTER
TUBES
C. E. Mfg. Co., Inc.
Providence, R. I.



ABC SOCKET POWER

(Continued from page 28)

coil. This is the only piece of apparatus not furnished with the kit, so that those who already have Browning-Drake sets wired for parallel filament operation can easily re-wire them with practically no additional expense. For complete constructional details, it would be best to obtain one of the Browning-Drake construction booklets, which are especially useful for the novice who requires more details than could be given in this limited space.

LIST OF PARTS FOR BROWNING-DRAKE RECEIVER

- 2 National tuning units—Coils, condensers and dials.
- 1 Browning-Drake foundation unit—panel and subpanel, drilled, with sockets and grid leak mountings.
- 1 National impedanceformer (1st stage).
- 1 National impedanceformer (3rd stage).
- 1 .1 mfd. Tube condenser, special type.
- 3 .001 mfd. Tinytube fixed condensers.
- 1 .006 mfd. Tinytube fixed condenser.
- 1 .00007 mfd. Tinytube fixed grid condenser.
- 1 Yaxley filament switch.
- 1 Yaxley 30 ohm rheostat.
- 8 Eby binding posts (Ant, A plus, A—, B45v, B amp, C—, two blanks).
- 1 Precise Midget .0001 mfd. variable condenser.
- 1 Browning-Drake 33 ohm resistance cartridge.
- 1 Browning-Drake balancing or neutralizing device.
- 3 Resistances (.1 meg., ¼ meg., 8 meg. Electrad or Lynch).
- 1 National Tone Filter (when type 371 tube is used).
- Miscellaneous lugs and bus-bar wire.

Testing

TESTING the power plant is a simple matter, since there are very few adjustments. Obtain an ammeter having a scale of not over 1½ amperes, and connect it directly across the minus and plus *A* leads from the resistance group. Turn on the current supply, and the ammeter should read between .25 and .3 amperes. Adjust this current flow to about .25 amperes, either by means of the 150 ohm resistance, in the case of Combinations 1 and 3, or by changing the value of the Mazda lamps, in Combination 2. 40 watt lamps will normally be right for this circuit, but if the current is too low, substitute a 60 watt lamp for one of the 40 watt size. Do not use a 25 watt lamp, as it is not designed to carry more than .21 ampere.

When the filament circuit is roughly set in adjustment, connect the filament leads to the receiving set, insert the tubes in their sockets, and again place the ammeter in series with the *A* leads, adjusting the current to .25 ampere. Connect the *B* voltage taps, the 5 volt a. c. leads to the power tube, and place a voltmeter across the minus *A* and plus 180 volt *B* terminals. While the voltmeter will consume quite a few milliamperes, it will give a fair indication of the condition of the circuit, and if the voltage is very much above 180, the resistance in the power rheostat should be increased until the voltage is reduced to the proper value.

If the circuit of Fig. 4 is used for the power plant, the variable resistance in the 45 volt tap should be adjusted so that a reading of 41 volts is obtained using the ordinary 150 volt low resistance voltmeter. This will allow for a slight drop in voltage due to the current consumed in the meter, and the actual voltage will rise to 45 volts when the voltmeter is disconnected.

The only adjustment to the receiver will be the neutralizing condenser in the r. f. amplifier circuit. This condenser consists of a metal disk with worm adjustment, which is brought close to the antenna coil windings, so as to introduce a capacity between the r. f. tube plate and the low voltage end of the antenna coil. This condenser should be adjusted so that when a station is being received, and the tickler has been advanced until the detector is oscillating, with resulting high pitched whistle, the volume of the whistle but not the pitch is changed by varying the .0005 mfd. condenser shunted across the antenna coil.

TROUBLE SHOOTING

(Continued from page 29)

method is described herewith that has met with great success. First procure a tube base of the type used in the receiver. From this bring out four leads. These are easily soldered into the prongs and run to their respective positions on a socket that will fit the power tube you intend to use. Break the grid lead and add whatever battery is necessary to provide the correct bias. The same is done with the plate circuit to make up the *B* voltage. The power tube may then be placed wherever most convenient and the receiver remains intact in event it should ever be desired to change back to the original hook up.

A persistent crackling noise in a receiving set, accompanied by a fading or complete disappearance of signals, is usually caused by a poor contact in the aerial circuit, tube sockets, jacks, rheostats, switches, or bearings of the variable condensers. If the noise continues after the aerial and ground have been disconnected from the set, it is in the set; but if it stops when this is done, it is in the aerial circuit. If it is found to be in the set, a broken connection or poorly soldered joint may be found to be the trouble. One of the main sources of crackling noises is run down *A* or *B* batteries. In hunting the cause of the noise, the batteries should be tested first; then the different contacts should all be gone over, sandpapered, and made tight. If the noise does not stop then, it will be necessary to give the set a more thorough examination.

NEW VACUUM TUBES

(Continued from page 48)

The New A. C. Magnatron Tubes have filaments designed for direct operation from a step-down transformer connected to the lighting circuit. The A. C. 227 is a five-prong tube with an independent heating element. It may be used in a special socket or in an adaptor which fits the usual four-prong socket. It is suitable for use as a detector or amplifier. The A. C. 226 is a four-prong tube for use as an amplifier only. The A. C. 280 is a full wave rectifier and the A. C. 281 a half wave rectifier.

The Armor A. C. 110 tube takes $2\frac{1}{2}$ amperes alternating current at 1 volt, thus eliminating the need for "A" battery. Its amplification factor is 7.5 to 8, its mutual conductance is 800-1400 micromhos and its impedance 6,000 to 12,000 ohms for plate voltages of from 22 to 157. It is claimed that objectionable a. c. hum has been successfully diminished and that it is used in the new Garod EM electric power receiver.

NEW R. F. TRANSFORMERS

(Continued from page 53)

The Camfield Duoformer is a radio frequency transformer designed to minimize oscillation. It is of the dual solenoid shape wound

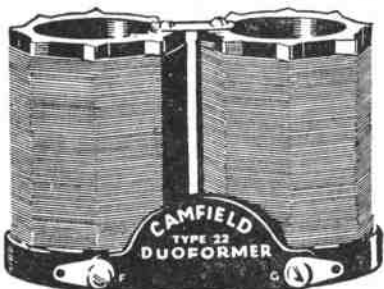

on an air-spaced bakelite form, giving a confined field. The primary is wound with high resistance wire to permit a large plate load without oscillation.

The Remler r. f. amplifier, is a three-stage shielded unit which can be used ahead of a detector and audio amplifier. It is especially adapted for use as a "front end" in the infradyne circuit. Complete equalization is accomplished with an antenna compensator which is included with the amplifier.

Push Pull
Input
Transformer



Push Pull
Output
Impedance



The New Symphonic Push Pull gives great power with quality

You who love rich bass notes and tonal brilliancy will find this beautiful pair of Samson brush-copper-finished audio units — Push Pull Input Transformer and Push Pull Output Impedance — as far ahead of the old-style push pull transformers as the Samson Symphonic Transformer is ahead of the old audio transformer.

These units have brought back into its own the push pull circuit, which eliminates tube harmonics and was only condemned because of the poor transformers that were used.

With two type 171-power tubes having but 180 volts on their plates as much undistorted volume can be obtained as with a type 210 tube having 400 volts on its plate in an ordinary amplifying circuit — and two type 210 tubes can be used with these units for dance-hall volume.

The Samson Symphonic Push Pull Input Transformer will satisfactorily work into tubes up to 50 watts capacity.

Unfiltered AC current may be used on the filament in push pull circuits without hum in either first and second stages, or both stages.

The Push Pull Output Impedance eliminates the distortion always found in any transformer — no matter how well it is made.

Broadcast stations and laboratories, where a minimum of distortion is required, have used Samson Push Pull Audio Units for the past year. This is the first announcement of the availability of these units for public use.

Send for free reprint article on a complete audio amplifier.

SAMSON ELECTRIC COMPANY

MAIN OFFICE:
CANTON, MASS.



Manufacturers
Since 1882

Factories at Canton and Watertown, Mass.

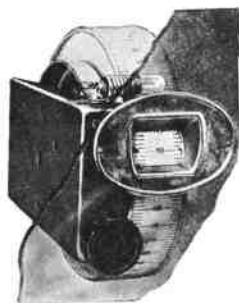

The Remler drum dial is designed to drive all standard makes of condensers whether single or ganged. Its spiral gear dial gives quiet operation without back-lash. It is easily mounted requiring only a round drilled hole in the panel.

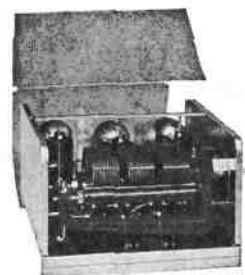

The drum is 15 in. in circumference and has 200 divisions on the calibration strip, which is rigidly mounted yet easily removed for renewal. It is illuminated with a 6 volt lamp.

Tell them that you saw it in RADIO

X, P, Q, R, M, Z, T, !

An announcement on the average loud speaker, may sound like this; but with the "ENSCO" 3 foot cone or roll speaker you hear every word and every note through the heaviest static.

Kit **GENUINE** Kit
\$10 "ENSCO" \$10

Why has "ENSCO" been endorsed by all leading magazines and the foremost newspapers? Because—it is the most highly developed big cone assembly now offered to the public, it reproduces all frequencies and greatly reduces static. The "ENSCO" unit is the only direct-drive unit for large cone speakers.

Manufactured under U. S. Patent No. 1630119; "ENSCO" Cushion Drive Patent No. 1163854; Cone Diaphragm Patent No. 1093655 and other patents pending.

Assemble the "ENSCO" speaker in less than an hour. It works on any set with any power. No filters or chokes necessary, 90 to 250 volts without protection or 500 volts with transformer. Six different types to choose from. Cones beautifully decorated and marked for assembly. Wall, pedestal or console; all fully described in illustrated instruction book.

Sold under absolute (money back) guarantee

ENGINEERS SERVICE COMPANY

25 Church Street.....New York City
73 Cornhill.....Boston
28 E. Jackson Blvd.....Chicago

Ask your dealer or mail order to nearest office. Send money order, check or cash, or we will ship C.O.D. We pay shipping charges.

FROST-RADIO

Parts for the
INFRADYNE

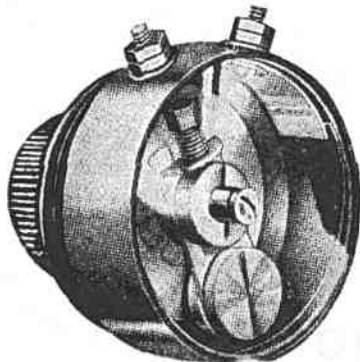

Type 886 Super-Variable
High Resistance

Absolutely noiseless. Turns easily and smoothly because of roller contact arm and there is absolutely no wear on the resistance strip. Nickel-plated case, with Bakelite pointer knob.
No. 886, list.....\$1.50

HERBERT H. FROST, Inc.
190 North La Salle Street, Chicago
New York Los Angeles

KARAS EQUAMATIC MANUAL

Price 10c.

Build the Karas Equamatic 5-Tube Radio Sensation—the most selective receiver ever designed. Mail 10c today for 16-page Manual of wiring diagrams and complete instructions for building this remarkable receiver.

Address:

KARAS ELECTRIC COMPANY
4031G No. Rockwell St. Chicago, Ill.

BEST'S SHIELDED

SUPER BLUE PRINTS \$1.00

"Radio" San Francisco

MAHONEY'S HUNCH

(Continued from page 80)

"Exactly. I've been looking for eight months for just what you gave me tonight. That's why I'm inclined to let you in on the finish."

The red-headed youth's hand shot out.

"Put her there, fellah," he said. "What do we do? Get a couple of guns and pot 'em or slam the door shut and turn the key?"

"Neither," said Mahoney. "Jake Dallas won't hit until tomorrow night. We've got a lot of time."

He explained the whole program as he had worked it out.

"When you translated that stuff of Banjo Ed's" he said, "you got in on about five thousand dollars reward money, Bud. If we get the gang, I'll see you get it."

Bud Wallace half rose from his seat and sank back again.

"Five thou . . . Oh, Lordy! Oh—mama!" The smile went off his face suddenly and his face went grim. "Listen—I got a personal interest in this thing m'self when I come to think about it."

"How's that?" asked Mahoney.

"My old man's the watchman. Now—gimme somethin' to do!"

"I'd like to get to the county seat tonight," said Mahoney. "Can it be done?"

The operator considered.

"Lissen—I got the fastest bus in the county, outside," he said. "I scoot the sheriff around sometimes. Him and my old man are great pals. Let's go!" They went.

That was the way of it. A whirling dash through the night to the county seat. The quick but guarded movement of armed men the following morning . . . a number of strange faces in and about Pinkton, with a feeling of tenseness in the air. At the First National bank things went along as usual, the bank closing at three o'clock in the afternoon without incident. At 9 o'clock Pinkton went to bed as usual on non-concert nights, and the metropolis dropped into a semi-illuminated gloom.

Jake Dallas and his crowd swept into Pinkton around midnight, in two machines, lights out, number plates changed, engines tuned to the maximum of speed and efficiency. There were ten in the party, every one carefully picked. Each had his orders. When the machines came to a halt, two hurried over to the telephone office to cripple the service. Another pair hunted up the main power and light feeders into the town. The rest followed Jake Dallas.

The street was empty and silent as the gang approached the First National. Two squatted down in front of the door, affixed a queer-looking, claw-footed arrangement to the door and shut

down a lever. The lock snapped with a sharp report that echoed in the street as the "comealong" did its work, and the door swung open. Jake ran an eye up and down the street, motioned to the others and stepped inside. The next instant, hell broke loose.

From the roof of a building across the street a machine gun began pouring a copper hail into a group in the bank doorway, the coughing chatter of the gun drowning out the screams. Shotguns belched from doorways, and a rifle or two spat toward the same spot. Jake was down the first volley, and the others scattered, striking back like cornered cobras, shooting at shadows, at flashes, at anything that moved. Taken at a disadvantage it was whipped before it got into action. Those that were not killed or wounded held up their hands and cried for mercy. One lone bandit tried a machine and Mahoney stepped from a doorway and drilled him through the chest.

Half way across the county the next morning, Banjo Ed, trudging along with his pack on his back and his dog at heel, was halted by two men in a machine. One showed a star and thrust a gun into Ed's ribs and his career as a line-up man and radio entertainer was over forever. En route to the county jail, he told a lot of things, and his testimony cinched the five already held there en route to state's prison. The end of the Dallas gang was tragic but effective!

It was a week later that Jerry Mahoney made his report of the cleanup to Sam Barry, his chief, sitting in the latter's office, in one of Barry's easiest chairs, and smoking one of the chief's most expensive cigars. Sam Barry had a bunch of grateful telegrams from a score of banks that brought blushes to Jerry Mahoney's face.

"The credit ain't coming to me," he protested warmly. "It goes to that red-headed ship operator, Bud Wallace. He was the one that put me right. I learned a lot from him—him and Banjo Ed together. For one thing, I discovered that I should have taken up music and learned to play the banjo years ago when I was young."

"Gwan", said Sam Barry, who spoke police English with the best of them. "What's the use of playin' a banjo when you can play a hunch?"

And Jerry Mahoney, knowing the hopelessness of trying to convince him, let it go at that.

If an output transformer is used in an audio amplifier, it is generally a good plan to ground one side of its secondary (the secondary is the winding that connects to the loud speaker or head phones). This stunt will help to reduce set noises; and the alternating-current hum if a B-battery eliminator is used.

**NEW FACTORY - BUILT
RECEIVERS**

(Continued from page 44)

supply. This unit is made in two models, 104 for 60 cycles and 105 for 25 to 50 cycles, each delivering 180 volts maximum. It is controlled by an a. c. line switch on the set, this switch being combined with a volume control.

Buckingham

The Buckingham single control 6-tube chassis has three stages of tuned r. f., detector, and two stages of transformer coupled a. f. amplification. The tuning dial is calibrated in degrees and wavelengths and has an indicator which moves

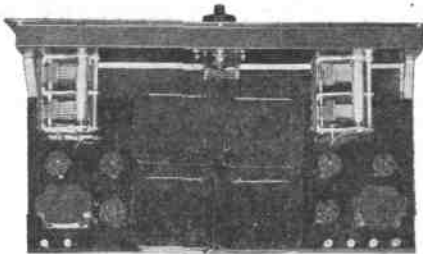

Rear View of Buckingham Chassis.

straight across the illuminated window. The panel is of etched bronze; the condenser gang control has no back-lash; the sub-panel wiring is enclosed in a steel housing. The set is shielded and rigidly braced being intended for installation in any standard cabinet. The panel is 7 by 18 in. and the depth is 10 in. The tuning is selective but not critical.

Atwater Kent

Two new models of Atwater Kent receivers were shown. Model 33 is a 6-tube set with single tuning control together with an antenna adjustment knob at the left of the station dial. It has three stages of tuned r. f., detector, and two stages of audio. It is designed to be non-radiating and non-squealing. It is assembled in a mahogany table cabinet.

Model 50 is a seven-tube shielded receiver having four stages of tuned radio. Otherwise it is similar to Model 33. With the separate shielding furnished by the r. f. parts and the further shielding provided by complete encasement in a metal container. This set is remarkably selective and free from extraneous noises.

Announcing . . .

**The NEW WESTON
2" and 3 1/4" Diameter**

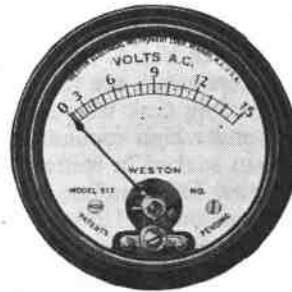

**A. C.
Panel
Instruments**

Model 517
2-in. diameter

IT is no longer necessary to plan your small A. C. panels in terms of large instruments in order to secure a high degree of operating economy and performance. Miniature but reliable instruments are now available which can be used to solve your small panel problems—instruments that are accurate on any commercial frequency, that have an exceptionally high resistance with a low power consumption. Moreover they are moderately priced. These instruments are made as Voltmeters, Ammeters and Milliammeters in both 2-in. and 3 1/4-in. sizes with flush-style cases for panel mounting. There is no substitute for Weston quality and these new instruments meet every rigorous Weston specification.

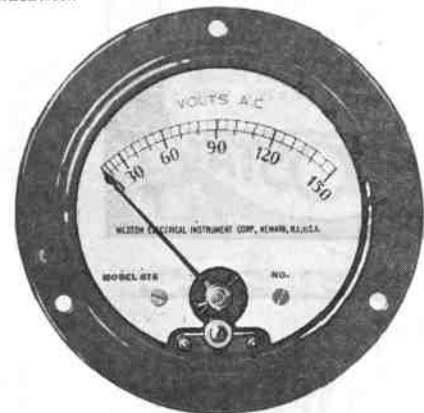

Model 476
3 1/4-in. diameter

PACIFIC COAST REPRESENTATIVES

Graybar Electric Company, Inc. 84 Marion Street
Seattle, Wash.
J. H. Southard
San Francisco, Calif.

A. A. Barbers
Los Angeles, Calif.
Repair Service Laboratory
682 Mission Street
San Francisco, Calif.

WESTON ELECTRICAL INSTRUMENT CORPORATION
156 Weston Avenue, Newark, N. J.



STANDARD THE WORLD OVER
WESTON
Pioneers since 1888



Portable Short Wave Transmitter



Wavemeter
10 to 110
Meters **\$17**
Complete

Complete with all accessories
including one power supply

\$90.00

We are glad to quote prices on
complete amateur and commercial installations

Crystal Control a Specialty



50-Watt **\$2.00**
Socket

TRANSMITTING EQUIPMENT LABORATORIES
3675 Moneta Avenue Los Angeles, Calif.

play **safe**

CLAROSTAT

is the PERFECT variable resistor for every radio purpose: for

Micrometric regeneration for short wave receivers;
Variable grid leak for transmitting tubes;
Line control for voltage compensation;
B-eliminator voltage control;
Volume control;
R. F. tube plate voltage control,
and 57 other uses which will occur to you.

HOW and WHY is explained in a 32-page book "The GATEWAY TO BETTER RADIO."

Send 25c to

American Mechanical Labs, Inc.
285 N. 6th St., Brooklyn, N.Y.

WARNING! Don't be misled by poor imitations. Look for the name CLAROSTAT stamped on every genuine unit.

Send 25c for 32 page illustrated book

Now you can build the kind of a radio you have always wanted

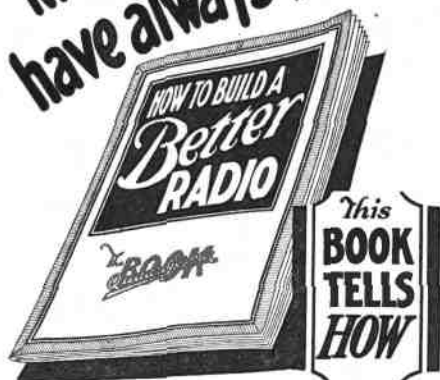

No matter whether you want to improve a set you now have or build a new one - get this book first. Tells how to build the latest one, two and three dial receivers - 5 to 7 tubes.

10¢ PREPAID
GEARHART-SCHLUETER, Fresno, Cal.

THE MAKING OF PAPER CONDENSERS

(Continued from page 64)

nating chamber in which the condensers are treated later.

Immediately after drying, the condensers are stacked with a metal plate between each, the stacks are clamped, and then placed in a hydraulic press where they are subjected to a pressure of 2000 lbs. per sq. in. These operations are shown in Fig. 5.

The condensers are then placed in the impregnating tank where they are again baked under high vacuum for two hours and then soaked in melted paraffine for two hours. The paraffine is steam heated under vacuum and drawn into the impregnator through a valve. This vacuum impregnation is continued until no air bubbles come to the surface of the paraffine as viewed through peep-holes in the cover. A pressure of 100 lbs. is then applied for an hour after which the impregnating chamber is cooled to

operation by means of a microfarad-meter which is directly operated on 110 volts, 60 cycle alternating current. All commercial condensers must test within 10% plus or minus, of their rated capacity and those which are outside of these limits are rejected.

BATTERY CHARGERS Contact Rectifiers

The Rectox trickle charger employs as rectifying elements a series of copper discs, one side of which is coated with copper oxide. These have the property of conducting an electric current in but one direction, so that in conjunction with a step-down transformer they may be used to charge a 6 volt storage battery at a 1/2 ampere rate from 110 volt a. c.

The Kuprox "A" unit utilizes a new metallic rectifying element, having unilateral conductivity so

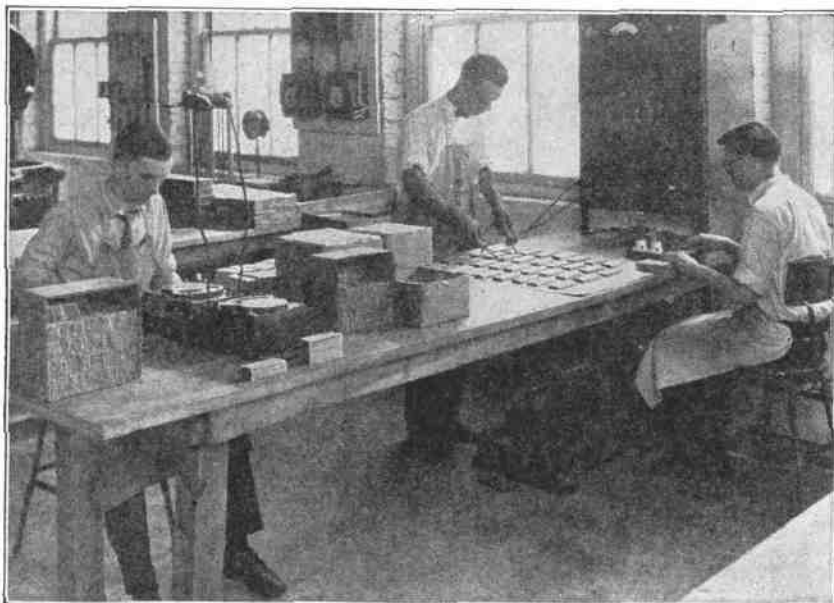

Fig. 6. Testing Condensers.

160 degrees F. and the paraffine returned to the liquor tank.

After the condensers have been removed for cooling and the clamps have been removed they are subjected to the tests illustrated in Fig. 6. The operator in the middle is applying voltage break down test. The testing pencils may readily be noted in each hand directly connected to the switch board which in turn is operated by the motor and generator under the right hand end of the bench. This flash test eliminates all condensers which will not stand the voltage for which they were made, and is particularly important in B battery eliminator work which requires a condenser that will stand up under continued use.

The operator on the right is using a microammeter which is also directly connected to the switch board for testing the insulation resistance. The operator on the left is making the third testing

as to deliver direct current from an a. c. source. This unit is especially intended to replace electrolytic or other rectifiers in any of the stand-



ard types of trickle chargers and is accompanied by detailed directions for making the change with each type. It may be connected as either a half wave or full wave rectifier.

Tell them that you saw it in RADIO

Simplicity!

H.F.L. Transformers



NO PLATE OR GRID WIRES

H. F. L. Units have been used, approved and most highly endorsed by Radio News, Citizen's Radio Call Book, Radio Review, Radio Age, Radio Engineering, Radio Mechanics, Chicago Evening Post and Daily News. H. F. L. are the finest transformers known to Radio—un-

Note the Simplicity of Construction
 No Critical Valves
 No Grid Condensers
 No Grid Leaks
 No Balancing Necessary

excelled for Power, Selectivity and Purity of Tone.

Perfectly matched, skillfully designed, carefully made, rigidly tested—in a word—H. F. L. transformers are technically correct to the minutest detail.

The Efficient Units for Better Reception

Manufactured by

HIGH FREQUENCY LABORATORIES

131 NORTH WELLS STREET

CHICAGO, ILLINOIS



H-210 Iron core transformer with an exceptionally high amplification factor. Range 22,000 to 42,000 cycles.

Price \$8.00

H-215 Air core transformer, tuned stage, designed to amplify signals at a maximum efficiency of 37,000 cycles. Each unit carries the laboratory calibration.

Price \$8.00

F-320 Audio frequency transformer which will amplify signals to greatest volume with incomparable faithfulness of tone. These units are the result of an entirely new principle in transformer construction.

Price \$8.00

L-425 Radio Frequency Choke Unit.

Price \$5.50

L-430 Low Loss Radio Frequency Transformer.

Price \$5.50

Jobbers, Dealers: Write for Discounts

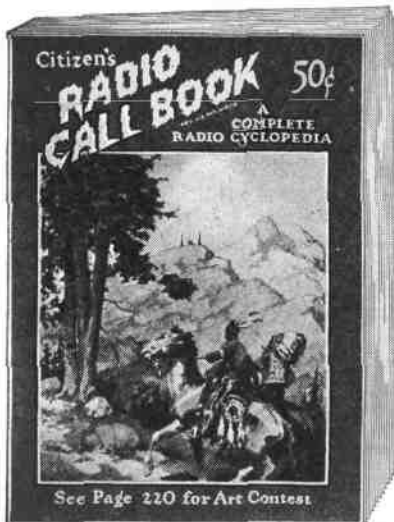

See Page 220 for Art Contest

RADIO'S GREATEST PUBLICATION

The March issue of the CITIZENS RADIO CALL BOOK is now available.

This issue contains a wealth of live radio information, including a complete and up-to-date list of all broadcasting stations in the world, showing schedules, wavelengths, etc.; a wonderful picture section of 150 radio celebrities, a new department known as Ampere Andy's Assistors, giving the latest shop hints, showing illustrations how to maintain and repair your receiver.

SEVENTEEN FEATURE ARTICLES

This section is known throughout the entire radio world as having the most complete construction information available. Every receiver has been designed and thoroughly tested in our laboratories. The illustrations and accompanying drawings have been very carefully prepared by a staff of trained editors, radio engineers and radio draftsmen. Here you will find your favorite circuit so simply described that any novice can easily construct by following these specifications.

The CITIZENS RADIO CALL BOOK is published four times yearly, January 1st, March 1st, September 1st, and November 1st. You may now subscribe by using the coupon below for one, two or three years and save money. By subscribing you will receive each issue by mail promptly upon date of issue.

Fill in the coupon at the bottom of this ad and mail at once.

TEAR OFF HERE

CITIZENS RADIO SERVICE BUREAU, Inc. Publishers
 508 So. Dearborn St., Chicago, Ill., U. S. A.

Publishers

O

Date.....192.....

Please enter my subscription for the CITIZENS RADIO CALL BOOK for [] one year, \$1.75; [] two years, \$3.25; [] three years, \$4.50. Enclosed please find.....in payment for same, mailed postpaid four times yearly, January, March, September and November. Canada and Foreign \$2.00 yearly.

Name.....Address.....

City.....State.....

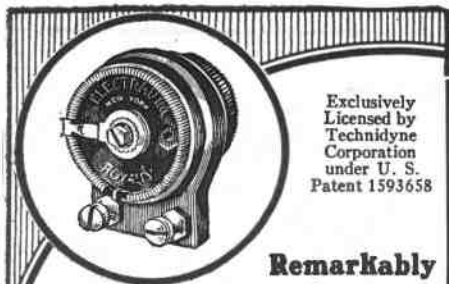

Exclusively Licensed by Technidyne Corporation under U. S. Patent 1593658

Remarkably Accurate!

ROYALTY VARIABLE HIGH RESISTANCES

The accuracy and dependability of these quality resistances under all conditions encountered in radio is almost uncanny.

For this reason they are the choice of leading radio experts.

1. Resistance element not impaired by mechanical wear.
2. Same resistance always obtained at same point.

A range for every purpose, designated A to 11. Type E \$2. All other types \$1.50

Write for free hook-up circular.

At your dealer's

Dept. 53, 175 Varick Street
New York City

ELECTRAD

**Best by YOUR test—
a confident challenge!**

For All Power Work



12 Watts
These units do not deteriorate or change in resistance value

EL MENCO HY-WATT TRADE MARK HEAVY DUTY RESISTORS

For best results with Raytheon and other power circuits you must have permanently accurate resistors capable of carrying heavy loads without change or deterioration. "HY-WATT" Heavy Duty Resistors dissipate up to 12 watts.

100-500-1000-2000-5000 ohms \$1.25
10,000-25,000-50,000 ohms \$1.50
100,000 ohms \$2.00

Write for full details and literature on El Menco Gridleaks and Resistors

Electro-Motive Engineering Corp.
127 West 17th St. New York, N. Y.



OUR SUPER-EXCELLENT CABINET ON SPEAKER CONSOLE

Radio Cabinets

This cut shows our Super-Excellent Table Cabinet on our Super-Excellent Speaker Console. This is only one of our 10 latest conceptions of Radio Furniture. We have an unusual display of Furniture designed and built exclusively as Radio Furniture.

Send for catalog and descriptions and you will find that we are listing and carrying, ready for immediate shipment a very beautiful line. From all forecasts it is apparent that Radio Furniture will be the dominating factor in radio sales this coming season. Sets in our Cabinets will make sales. Special Cabinets Built to order in quantities.

Ehlert Radio Furniture Company
2468 Lincoln Avenue, Chicago, Ill.

Show Rooms and Large Stock Carried in Chicago.

Manufacturers of: RADIO CABINETS, RADIO DESKS, RADIO CONSOLES, RADIO TABLES.

Majestic

100% Electric "B"
Gives your radio Full Strength Permanent "B" Power from the light socket

It does improve reception!

No acids or liquids—No hum.
Ask your dealer to demonstrate

<p>Majestic Standard-B Capacity Nine 201-A tubes or equivalent. 45 milliamperes at 135 volts. \$26.50 Raytheon Tube \$4.50 extra</p>	<p>MAJESTIC SUPER-B Capacity 1 to 12 tubes, including the use of power tubes. 45 mls. at 150 volts. \$29.00 (as illustrated) Raytheon Tube \$4.50 extra</p>	<p>Majestic Master-B Positive control of all output voltage taps. For sets having high current draw heavy biasing batteries. 60 mls. at 150 volts. \$31.50 Raytheon Tube \$4.50 extra</p>
--	--	---

FULLY GUARANTEED—SOLD ON EASY TERMS
GRIGSBY - GRUNOW - HINDS CO., 4580 Armitage Avenue, CHICAGO
W. J. SEROY, Pacific Coast Sales Mgr., 122 Broadway, Oakland, Calif.

(Continued from page 33)

For the experimentally minded great interest will center in adapting the new multi-element and a. c. tubes to old circuits. Methods of doing this will be described in these columns, together with discussions for assembling the best of the new kits.

There is no hobby more interesting and instructive than the building of radio sets. It offers opportunity alike to the novice and the most experienced workman. The novice learns the fundamental principles as he assembles the parts and then is ready to undertake the more difficult task of actually making his own equipment, should he be so inclined. Radio has revived the old time personal pride in individual handiwork more than any other factor of modern life.

AUDIO AMPLIFIERS

(Continued from page 50)

The Jefferson Concertone Transformer is claimed to evenly amplify all frequencies from 30 to 10,000 cycles. Its windings are vacuum impregnated and sealed in an upright enameled case so as to be



impervious to moisture. The core and windings are balanced so as to give a natural reproduction of voice or instrument.

Tell them that you saw it in RADIO

THE Simplicity of tuning
THE Efficiency of the Bakelite Shaft Condensers
and the Beauty of the Bronze Front Plate

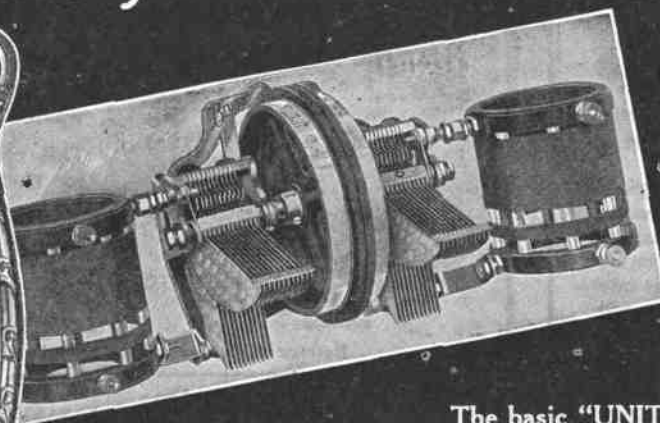
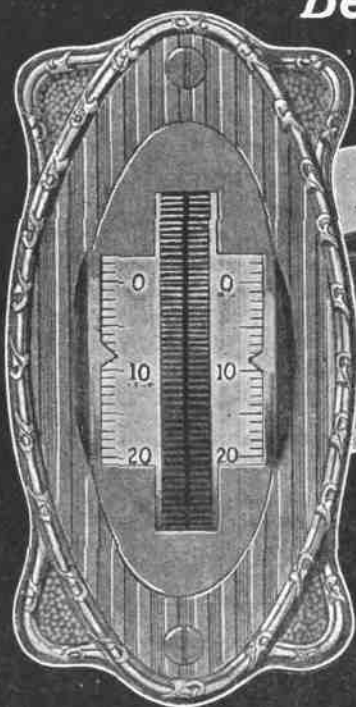

Makes the "UNITONE" the most desirable tuning device ever designed.

ALL BRUNO "UNITONES" may be mounted on a panel with only two screws.

The basic "UNITONE" consists of a frame upon which are mounted two condensers operated independently by two bakelite drums projecting thru a beautiful bronze plate. It may be obtained in all standard capacities. Completely assembled it lists at \$11.00.

Other "UNITONES" assembled with one or more Quartzite Coils for all popular circuits range from \$12.00 to \$21.00.

Booklet of Instruction and Blue Prints - 25c

BRUNO RADIO CORP., LONG ISLAND CITY, N. Y.

THE BRUNO UNITONE UNITS

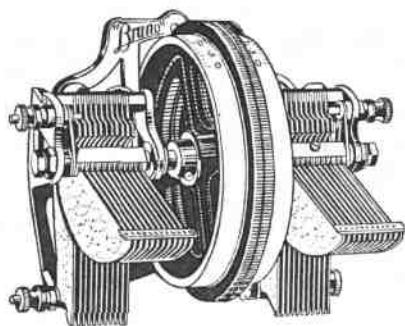

introduce a revolutionary simplicity in the construction and operation of home-built radio receivers. The basic unit consists of a drum control and two variable condensers.

The drum control has two parallel dials which project through a beautiful bronze escutcheon plate on the panel. These dials can be operated separately or can be adjusted as a single control unit by a slight pressure of the finger on both drums at the same time.

Each drum is attached to the shaft of a .0005 mfd. variable condenser of the straight line frequency type. There is no contact between the two shafts, each condenser being entirely insulated from the other.

With this arrangement the control of two tuning condensers is centralized in a single slot cut in the panel instead of having two controls at different points. This eliminates several mounting and wiring operations, the complete unit being mounted with only two screws.

Various combinations of coils, mounted at each end of the unit permit the use of this type in most of the standard circuits. The separate control feature of the double drum control makes the use of sub, or compensating condensers unnecessary. The coil units consist of windings on frames having bakelite end pieces and quartzite rods. These coils can be mounted to adapt the unit to various circuits.

Besides these unusual tuning units, the Bruno Corporation manufactures a number of quality radio parts such as coils, brackets, condensers, light switches, transformers, etc. It would pay the reader to find out more about these parts.



Licensed by
Rider Radio
Corporation
Pat'd 5-2-'16
Pat'd 7-27-'26
Patents Pending

**R. F.
Oscillations
Gone Forever!**

Phasatrols

**A True Balancing Device for All
Radio Frequency Amplifiers**

Imagine your set without the squeals caused by radio frequency oscillations! You can stop these oscillations and assure perfect, even reception by installing PHASATROLS. This new Electrad device simplifies tuning and lets distance come in clean and clear. Easily installed in any R. F. set—tuned, untuned or reflex. Price \$2.75.

At good dealers

Booklet showing how to install Phasatrol in your favorite circuit free upon request. Send for it.

Dept. 52, 175 Varick Street
New York, N. Y.

ELECTRAD

Amazing Value!

Radio Declares War on "B" Batteries

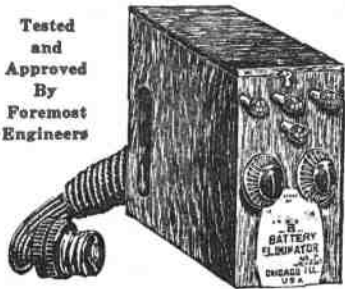

Tested and Approved By Foremost Engineers

A sudden revolt from set owners. A fight against the costly upkeep of "B" batteries! Startling tests revealed that the average life of "B" batteries is only a few months. Think of it. Not alone money wasted, but the grief that goes with it.

This amazing "B" Eliminator now used by thousands of set owners on every make of radio sets has revolutionized the "B" battery problem. Just plug it in light socket and turn on your set. Will operate from 1 to 15 tubes A.C. or D.C. current. 4 taps 10 to 135 volts. 45 mills. at 100 volts.

EDDYSON "B" Battery Eliminator

\$9⁹⁵ Complete

Nothing Else To Buy.

Money Back Guarantee.

**NO HUM
ACID OR TUBES.**

Better Reception and More Volume.

La Salle Merchandising Co.
309 S. LaSalle St., Dept. 53
CHICAGO, ILL.

LABALLE MERCHANDISING CO.
309 S. LaSalle Street
Chicago, Ill.

This coupon and money order for \$9.95 or C.O.D. will bring you an Eddyson "B" Eliminator.

Name _____
Street _____
Town _____ State _____

Look for **TOBE** Condensers and Resistors

At the R. M. A. Show
Chicago, June 13-18, at Booth 145

SOUND EXPERT ADVICE

On Radio and Scientific Patents
Specializing in Radio Patents and Trade Marks and Investigations Relating Thereto

John Flam, Patent Attorney
821 Merchants National Bank Building
Los Angeles California

HEAR the wonderful New Acme Speaker at your dealer's



ACME

for amplification

Valley "B" Power Unit

Manufactured by
VALLEY ELECTRIC CO.
ST. LOUIS, MO.



Out Goes Your A & B Batteries in comes the "VERNON"

the latest in **Batteryless Radio**

Radio or Phonograph Cabinet

Uses No A or B Batteries and works direct from your house Lighting Circuit... Ready to install in your own...



This Complete Electric Radio occupies very little space. Anyone can install it. You don't even have to know anything about a Radio.

Direct from Factory to You...

\$32⁵⁰

COMPLETE including TUBES!
[All you need is your own Cabinet and Loud Speaker]

PANEL 7 x 14 Inches

Today's Greatest Value!

This modern Radio is more efficient than many radios that sell for many times its price. The "VERNON" comes to you completely built—panel and sub-panel—wired by experts and every set is thoroughly tested before leaving the factory. Together with this Radio comes the "VERNON" Filter System which replaces both A and B Batteries.

The "Vernon" is the most economical radio that has yet been built
This Receiving Set uses less than one half as much electricity as is used by one ordinary house lamp.

The "VERNON" Batteryless Radio has a circuit different from any other make. It uses only three tubes, and its tone, selectivity and volume surprises everyone. This Radio uses a Tube Detector (No Crystals)

MAIL \$5.00, BALANCE C. O. D. Charges collect. Shipping weight 20 lbs.

Address your order to the **VERNON RADIO COMPANY**, 724 West Vernon Avenue, Los Angeles, California
All orders are sent out within less than 24 hours from the time they are received.

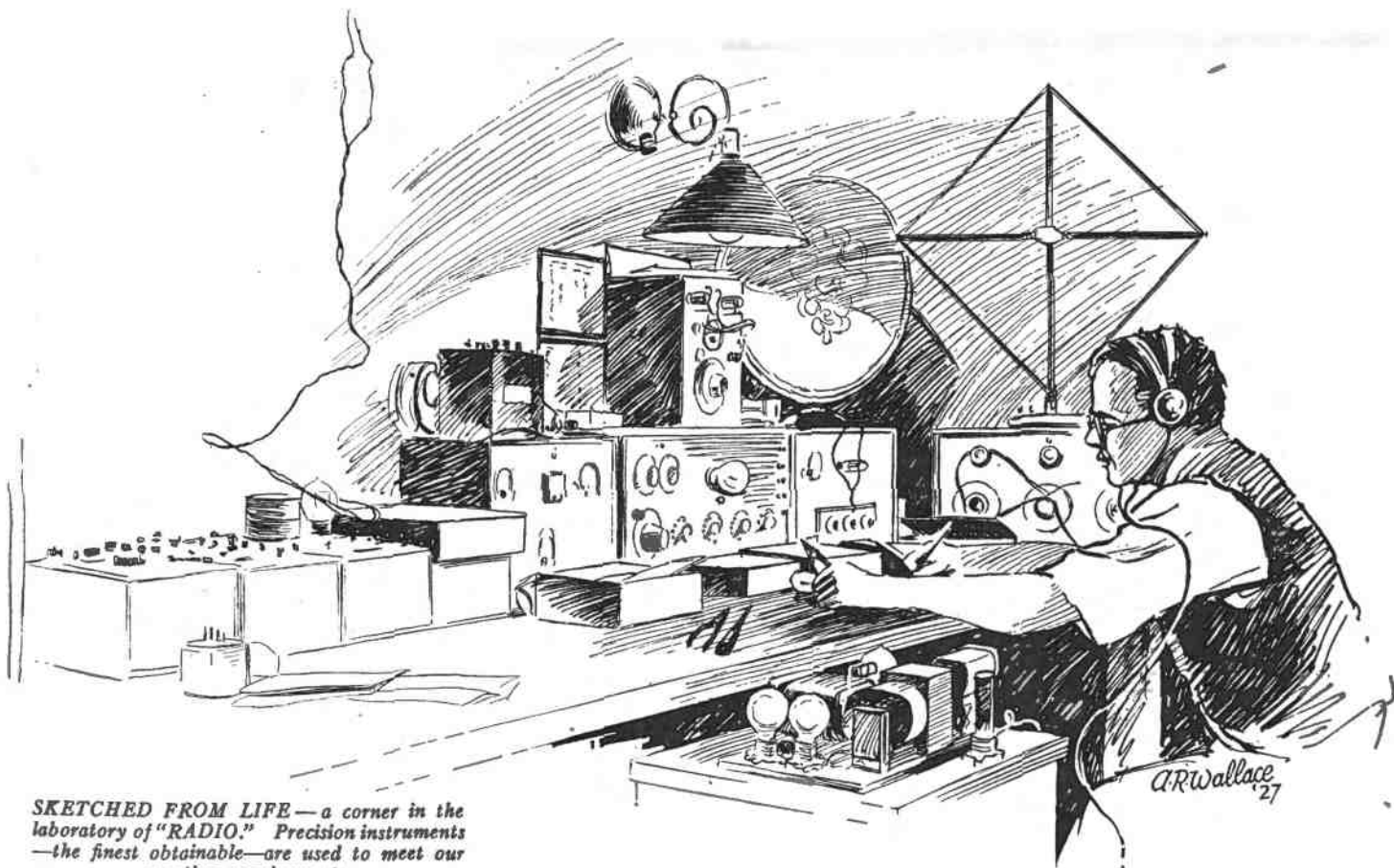

SKETCHED FROM LIFE—a corner in the laboratory of "RADIO." Precision instruments—the finest obtainable—are used to meet our exacting requirements.

The Laboratory of "RADIO"

—for the protection of our readers

Here you see pictured a part of "RADIO'S" Laboratory. In this laboratory we have at our disposal the necessary instruments for accurately measuring radio constants. Much of the apparatus was designed and built by Gerald M. Best, our Technical Editor. Here we can tell at a glance if a product is all the manufacturer claims for it. Here we protect our readers. Hundreds of radio devices to be tested reach us from the radio factories. But this is only a small part of the service rendered by the laboratory. To better serve the needs of our readers we are now testing, matching and calibrating radio parts of all kinds. We have a specially designed and constructed oscillator and gain set for matching audio and intermediate frequency transformers. We calibrate wavemeters from a "laboratory standard." Another device matches r.f. coils and variable condensers—enabling us to select the proper coils for each condenser bank. Then we have a precision instrument for measuring the capacity of small fixed

condensers. An instrument for calibrating receiving sets directly in wavelengths. A device for determining the constants and characteristics of vacuum tubes. With the latter device we can select "picked" or matched tubes for you. If you want a special detector—r.f.—audio or power tube we can supply it to you at regular retail price. We make no charge for picking, matching or testing tubes, transformers, coils and other radio parts when you purchase these from our laboratory. You are assured of receiving dependable merchandise when you buy your supplies from our laboratory. This service is open to all. It has proved to be of great value to the radio fan located in remote districts. The guarantee of complete satisfaction goes with all merchandise sold. Gerald M. Best and D. B. McGown are in charge of this laboratory. They are ready to serve you. Let us supply you with laboratory tested and matched parts for the next set you build.

HOW TO ORDER

When ordering parts from the laboratory be sure to specify Manufacturer's name, type number and style. C.O.D. orders accepted if half cash accompanies order. Prompt deliveries assured.

Testing and Calibration Laboratory
Pacific Radio Publishing Company
 Established 1917

PACIFIC BUILDING



SAN FRANCISCO-CAL.

What We Do For You

Pick vacuum tubes to most satisfactorily perform in the respective parts of your set. Sets of 5, 6, 7, 8, 9 or 10 tubes matched and selected for multi-tube receivers. The wise radio man knows the value of this service.

We sell matched and selected audio transformers of all makes. R. F. Coils, single and gang condensers. Parts for any kind of a set. We calibrate wavemeters. Match L. F. transformers and filters. Test parts for Socket Power units of all makes. Loud speakers and speaker kits can also be tested. We test audio transformers and supply frequency curves. In short, we can serve the needs of the most critical buyer—the man who knows the value of a service such as we render.

HOTEL CASS

644 CASS STREET
CHICAGO

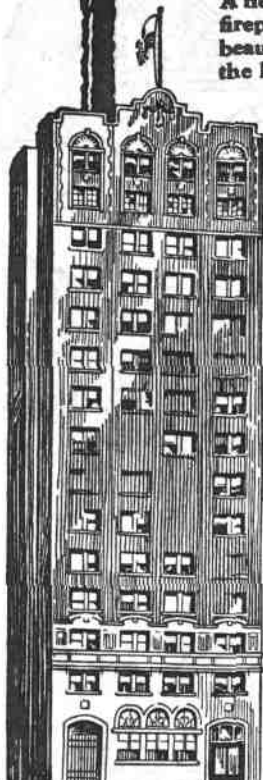

A new modern sixteen story fireproof hotel—one of the beauty spots of Chicago—in the heart of the fashionable near north side—close to the Lake—Lincoln Park, Oak Street Beach and all outdoor sports for which this city is famous.

*Just a five
minute walk
to the Loop*

Bus and surface transportation are immediately available. No expense or effort has been spared in making Hotel Cass the most luxurious, richly furnished hostelry in the entire middle west. Make your next visit to Chicago doubly pleasant by partaking of Hotel Cass hospitality.

**210 Rooms with Bath
all with outside exposure**

RATES

\$2.25 to \$2.75 per day, shower bath
\$2.75 to \$3.50 per day, tub bath
Double \$3.50 to \$6.00 daily
(Weekly \$15.50 and up.) Monthly
rates on request

For Reservations
write

H. G. PHILLIPS
Manager

RADIOADS

o o o

A Classified Advertising Section Read by Better Buyers.

o o o

The rate per word is eight cents net. Remittance must accompany all advertisements. Include name and address when counting words.

o o o

Ads for the Aug. Issue Must Reach Us by July Fifth

DOUGHNUT COILS Brand New—high grade coils, \$1.00, each, or \$3.00 per set of three, which includes 1 antenna coil and two tuning units. Limited number; order quickly. D. B. McGown, 435 Pacific Bldg., San Francisco, Cal.

BACK ISSUES OF "RADIO," perfect condition, 60c postpaid. Speedy service. R. M. Harris, Grimes, Calif.

"BEST CRYSTAL ON EARTH" — Postpaid, fifty cents each. Fully Guaranteed. Harry Grant, Jr., 904 Oak Grove Ave., Burlingame, Calif.

GET the 1927, Third Edition Revised of "Radio Theory and Operating" by Mary Texanna Loomis, member Institute of Radio Engineers. President and lecturer on Radio, Loomis Radio College of Washington, D. C. This is a thorough text and reference book of 886 pages, 700 illustrations and bound in flexible, red Kraft leather, lettered in gold. Used by practically all the radio schools in U. S. and Canada in addition to many Universities, Technical Colleges and High Schools. The standard reference book of the Department of Commerce, Radio Supervisors, and used by U. S. Naval Training Schools and Coast Guard Academy. The only radio book that is right down to date; contains much valuable matter never before published; it covers the field more thoroughly than any six radio books on the market. Price \$3.50, postage paid to any place in U. S. and Foreign countries. Get it of your book dealer. If he does not handle, send check or money order to Loomis Publishing Company, Dept. X, 405 9th St., Washington, D. C.

SET BUILDERS—We furnish jobs for you. (No fee) Competent men needed today in every community to build LC-27, Hammarlund-Roberts, Ultra-dyne, Loftin-White and Browning-Drake sets. Big money for you if you can qualify. Register NOW, giving particulars, experience, references. Allen-Rogers, Inc., 118 E. 28th, New York City.

BAKELITE PANELS, Tubes and Rods. Engraving and Drilling. W. A. Vetter, 24 12th St., San Francisco, Calif. (6T)

FIVE HUNDRED CYCLE generator, 2.5 KVA, 220 volts, 500 cycles, with direct connected 2 KW 125 V DC compound wound generator. Driven by 5 HP 3 phase 220 volt 60 cycle AC motor. For sale at \$300.00. Fine for large tube set. Can supply transformer to suit. D. B. McGown, 1247 Forty-seventh Ave., San Francisco, Calif.

FREE—Selective Crystal Set Hook Up. Send two cent postage stamp with request. California Radio Minerals Co., 904 Oak Grove Ave., Burlingame, Calif.

BARGAIN—Torrington vacuum cleaner, complete with all attachments; in perfect condition, cost \$70.00. Will sell for \$28.00. G. M. Best, 435 Pacific Bldg., San Francisco.

VACATIONISTS!—Just the set for your summer home—H. Earle Wright 3 Tube Receiver, regenerative, works with either wet or dry batteries, fine tone, good as new. Will sell for \$15.00. M. Alexander, 721 McKinley Ave., Oakland.

125 Henry Chokes for B Eliminator Service—Current carrying Capacity 120 milliamperes—While they last \$3.00
Laboratory, 435 Pacific Bldg.,
San Francisco, Calif.

USE "RADIO'S" NEW LABORATORY SERVICE

Write today for rate schedule for matching and testing your radio parts. We are equipped to give you prompt service.

"RADIO"—Pacific Building, San Francisco, Cal.

To All Readers of "RADIO"

AT the big Chicago Radio Show arrangements were completed between the publishers of "RADIO" and the publishers of "CITIZENS RADIO CALL BOOK" whereby anybody can now get both of these magazines for exactly the price of one. This unusual and exceptional offer is open to all. If you are already a subscriber to "RADIO" you can send \$2.50 and extend your subscription to "RADIO" for another full year and get the "CITIZENS RADIO CALL BOOK" for a full year without an extra penny of cost. If you bought both of these magazines from a news-dealer you would pay \$5.00 a year. Save \$2.50 — exactly half — by subscribing now to BOTH magazines for the price of one. We advise you to fill in the subscription coupon now — before you turn this page.



YOU SAVE 50%
by mailing the coupon now

Your subscription will start with the August issue of "RADIO" and September issue of "CITIZENS RADIO CALL BOOK."

COUPON

"RADIO"
Pacific Building
San Francisco, California

Here is \$2.50. Send me "RADIO" and "CITIZENS RADIO CALL BOOK" both for one full year as advertised in "RADIO" for July.

Name.....

Address.....

City and State.....

REMLER

REMLER

REMLER

Infradyne

Specified in these circuits
• Because •
the leading set-builders recognize
the high efficiency of this amazing instrument.

World's Record Super-Nine

Nine-in-Line

Lincoln

Best's
Super-Heterodyne

One-Spot Super

Quadrphase

Citizen's
Super-Eight

Victoreen

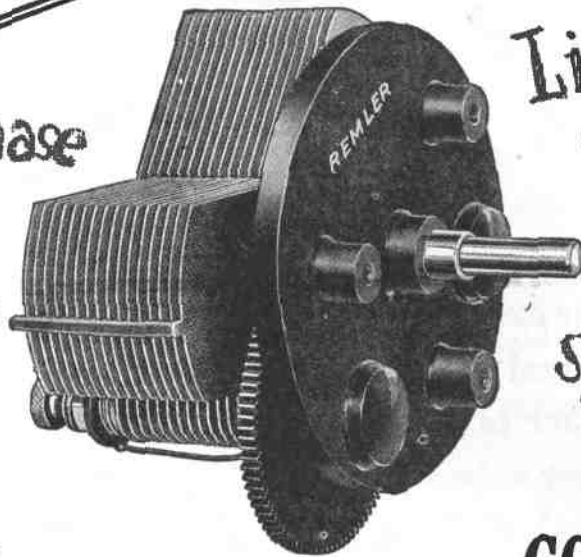

REMLER

Twin Rotor

CONDENSER

Famous Designers

must put their confidence in parts of proven merit. If you were designing a new circuit, what parts would you specify? Would you buy the cheapest you could find, or would you demand maximum efficiency?

Of course, you know the answer. You would do exactly what radio engineers have done. After testing and trying many makes of condensers, you would find that the Remler Twin Rotor exactly met your requirements. SO, when next you are buying parts, remember that ONE condenser meets your utmost requirements in accuracy, efficiency and performance.

What It Is—and Does

Condensers are among the few moving parts in a radio circuit. They require the utmost rigidity in construction and the greatest care in assembly. Into the Remler Twin Rotor Condenser is built a maximum of quality and durability. It is constructed like a Hamilton Watch or a Packard Car. Naturally, it does give superlative service. Of course, it operates with extraordinary smoothness. When you use it, you know the value of the Remler reputation.

Two Types { Straight Line Frequency
 { Straight Line Wave Length

Capacities { .0005 mfd. maximum
 { .00035 mfd. maximum
 { .0001 mfd. maximum

Price \$5.00

REMLER
GRAY and DANIELSON
Manufacturing Company



260 SECOND STREET

SAN FRANCISCO

EASTERN WAREHOUSE: ELKHART, IND.

REMLER

REMLER

REMLER

REMLER
REMLER
REMLER
REMLER
REMLER
REMLER
REMLER
REMLER
REMLER
REMLER

REMLER
REMLER
REMLER
REMLER
REMLER
REMLER
REMLER
REMLER
REMLER
REMLER

To prevent R. F. current from going astray

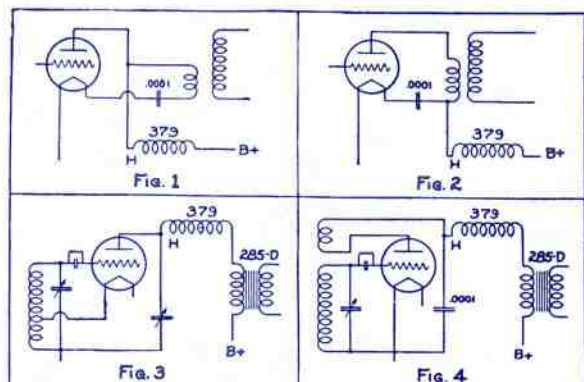

The figures in the above diagram show the more common uses for the Type 379 Radio Frequency Choke.



TYPE 379
Radio Frequency Choke
Price \$2.00

In many of the popular receiving and transmitting circuits, a radio frequency choke is recommended.

A choke is necessary wherever a parallel plate circuit is used in order to prevent the stage supply circuit forming a shunt for radio frequency current, and is of material assistance in reducing coupling between stages using a common plate supply.

The Type 379 Radio Frequency Choke has a high impedance over the entire broadcast and amateur wavelength range. It has an inductance of 60 millihenries and maintains an effective capacity of not more than 4 MMF between 20 and 640 meters.

Type 379 R. F. Choke, Price \$2.00

GENERAL RADIO CO., Cambridge, Mass.

GENERAL RADIO

PARTS AND ACCESSORIES

The General Radio Company has endeavored to make it possible for the experimenter to obtain its products with minimum of effort. A careful selection of distributors and dealers has been made. They are best suited to serve you. If, however, you are unable to obtain our products in your particular locality, they will be delivered to you, postpaid, direct from the factory upon receipt of list price.

An Announcement

BROWNING-DRAKE apparatus for the coming season will consist of both factory-built receivers and the well known parts for home construction.

A single control seven tube receiver using a special illuminated drum type dial mechanism will be ready for distribution during the Summer. Comparative tests indicate R. F. amplification far greater than any other receiver on the market. List price \$145, or in combination console \$185.

We also announce our new Model 5-A at \$105, and the continuance of the popular Model 5-R during the coming season.

The popularity of the official kit assembly for the home constructor and the new type T two tube assembly accounts for the ever increasing margin by which Browning-Drake parts outsell any other.

We invite you to write for full information on the new Browning Drake parts as well as on the complete line of factory-built receivers.

DEALERS: Browning-Drake now offers a complete line of receivers and kit parts. Sales of Browning-Drake parts during the past season were more than twice those of any other. Inquiries will receive prompt attention.

BROWNING-DRAKE CORPORATION
BRIGHTON ❖ MASS.

BROWNING-DRAKE
 **RADIO** 

H. L. KRIEDT CO., SAN FRANCISCO, CALIF.